

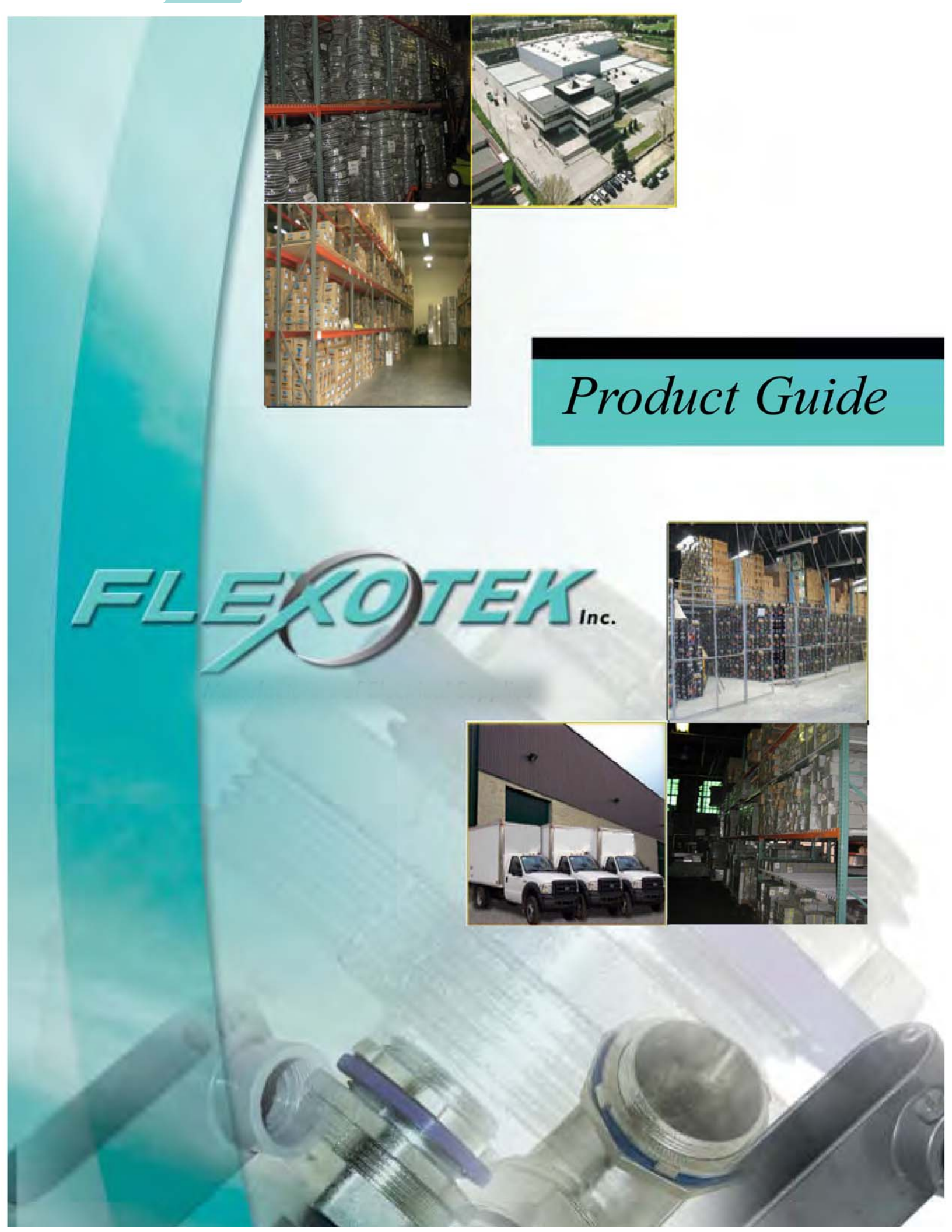

Product Guide

FLEXOTEK Inc.





Terms and Conditions

Minimum Charge

\$100.00 minimum purchase per order.

Terms

2% Cash Discount, 10th proximo. Net 30 days, upon credit approval.
Cash Discount does not apply to freight charges.

Payment

C.O.D. charges must be paid in cash or certified check. Plus freight charge.

Sales Tax Exemption Certificate

Sales tax need not be added if we have your Sales Tax Exemption Certificate on file.
A Sales Tax Exemption Certificate need only be attached to your initial order.

Freight

Full freight allowed on shipments.
Invoiced at \$1,200.00 within the continental United States.
All prepaid shipments will be routed by Flexotek.

Pricing

Pricing in this catalogue are in effect as of the date on the catalogue. If you order any item with a forced price rise, we will notify you before shipping to allow you to cancel for a full refund, or to tell us to ship the merchandise. Orders shall be invoiced at prices in effect at time of shipment.

Prices are subject to change at our discretion without prior notice.



Terms and Conditions

Returns

Returned goods authorization must be obtained prior to returning any merchandise. A letter requesting return authorization must be submitted within 7 business days of your receipt goods.

This letter should include the date of your original order and the reason return is requested.

DO NOT return merchandise without authorization, as shipments that do not show our return goods authorization number will be refused.

Returns are subject to a 25% restocking charge.

Claims

In those very rare instances when a package is lost or an item is damaged in transit, we assume full responsibility for filing claims.

Just notify the carrier by mail and send us the delivery receipt explaining what was lost or damaged.

These must be done within 7 days of the receipt of merchandise.

YOU HAVE NO PAPER WORK OR INCONVENIENCE.

Back Orders

All back orders will be shipped unless otherwise notified by customer.

Warranty

All Flexotek products if properly used are guaranteed against mechanical, electrical and physical defects for one year after receipt of goods.

No other express warranties or guarantees are intended or implied and are expressly disclaimed.

Our obligation under this guarantee shall be limited to furnishing new replacement material in exchange for damaged material inspected by us and found to be defective in material or workmanship.

Any other direct or consequential costs are expressly excluded.

\$75.00 SERVICE CHARGE APPLIES ON ALL RETURNED CHECKS.

ALUMINUM DIE CAST CONDUIT BODIES

RIGID



LB SERIES



ITEM CODE	TRADE SIZE	INNER CASE	MASTER CASE
LBT50	1/2"	10	100
LBT75	3/4"	10	50
LBT100	1"	5	25
LBT125	1 1/4"	2	10
LBT150	1 1/2"	2	10
LBT200	2"	1	5
LBT250	2 1/2"	-	1
LBT300	3"	-	1
LBT350	3 1/2"	-	1
LBT400	4"	-	1

LL SERIES



ITEM CODE	TRADE SIZE	INNER CASE	MASTER CASE
LLT50	1/2"	10	100
LLT75	3/4"	10	50
LLT100	1"	5	25
LLT125	1 1/4"	2	10
LLT150	1 1/2"	2	10
LLT200	2"	1	5
LLT250	2 1/2"	-	1
LLT300	3"	-	1
LLT350	3 1/2"	-	1
LLT400	4"	-	1

LR SERIES



ITEM CODE	TRADE SIZE	INNER CASE	MASTER CASE
LRT50	1/2"	10	100
LRT75	3/4"	10	50
LRT100	1"	5	25
LRT125	1 1/4"	2	10
LRT150	1 1/2"	2	10
LRT200	2"	1	5
LRT250	2 1/2"	-	1
LRT300	3"	-	1
LRT350	3 1/2"	-	1
LRT400	4"	-	1

FITTINGS

"America's Electricity Runs On Flexotek"

ALUMINUM DIE CAST CONDUIT BODIES

RIGID



T SERIES



ITEM CODE	TRADE SIZE	INNER CASE	MASTER CASE
TT50	1/2"	10	100
TT75	3/4"	10	50
TT100	1"	5	25
TT125	1 1/4"	2	10
TT150	1 1/2"	2	10
TT200	2"	1	5
TT250	2 1/2"	-	1
TT300	3"	-	1
TT350	3 1/2"	-	1
TT400	4"	-	1

C SERIES



ITEM CODE	TRADE SIZE	INNER CASE	MASTER CASE
CT50	1/2"	10	100
CT75	3/4"	10	50
CT100	1"	5	25
CT125	1 1/4"	2	10
CT150	1 1/2"	2	10
CT200	2"	1	5
CT250	2 1/2"	-	1
CT300	3"	-	1
CT350	3 1/2"	-	1
CT400	4"	-	1

FITTINGS

ALUMINUM DIE CAST CONDUIT BODIES

COMBINATION FITTINGS - SET SCREW RIGID



LB COMBO



ITEM CODE	TRADE SIZE	INNER CASE	MASTER CASE
LBC50	1/2"	10	100
LBC75	3/4"	10	50
LBC100	1"	5	25
LBC125	1 1/4"	2	10
LBC150	1 1/2"	2	10
LBC200	2"	1	5

LL COMBO



ITEM CODE	TRADE SIZE	INNER CASE	MASTER CASE
LLC50	1/2"	10	100
LLC75	3/4"	10	50
LLC100	1"	5	25
LLC125	1 1/4"	2	10
LLC150	1 1/2"	2	10
LLC200	2"	1	5

LR COMBO



ITEM CODE	TRADE SIZE	INNER CASE	MASTER CASE
LRC50	1/2"	10	100
LRC75	3/4"	10	50
LRC100	1"	5	25
LRC125	1 1/4"	2	10
LRC150	1 1/2"	2	10
LRC200	2"	1	5

FITTINGS

ALUMINUM DIE CAST CONDUIT BODIES

COMBINATION FITTINGS - SET SCREW RIGID



T COMBO



ITEM CODE	TRADE SIZE	INNER CASE	MASTER CASE
TC50	1/2"	10	100
TC75	3/4"	10	50
TC100	1"	5	25
TC125	1 1/4"	2	10
TC150	1 1/2"	2	10
TC200	2"	1	5

C COMBO



ITEM CODE	TRADE SIZE	INNER CASE	MASTER CASE
CC50	1/2"	10	100
CC75	3/4"	10	50
CC100	1"	5	25
CC125	1 1/4"	2	10
CC150	1 1/2"	2	10
CC200	2"	1	5

FITTINGS

"America's Electricity Runs On Flexotek"



5361 Preston Ct • Brooklyn, NY 11234 • Tel. 718-257-9300 • Fax. 718-257-9303 • 1 866-4FLEXOTEK • www.flexotek.com

ALUMINUM DIE CAST CONDUIT BODIES

COMBINATION FITTINGS - SET SCREW RIGID

COVERS AND GASKETS ATTACHED



LB COMBO



ITEM CODE	TRADE SIZE	INNER CASE	MASTER CASE
LBC50-CG	1/2"	10	100
LBC75-CG	3/4"	10	50
LBC100-CG	1"	5	25
LBC125-CG	1 1/4"	2	10
LBC150-CG	1 1/2"	2	10
LBC200-CG	2"	1	5

LL COMBO



ITEM CODE	TRADE SIZE	INNER CASE	MASTER CASE
LLC50-CG	1/2"	10	100
LLC75-CG	3/4"	10	50
LLC100-CG	1"	5	25
LLC125-CG	1 1/4"	2	10
LLC150-CG	1 1/2"	2	10
LLC200-CG	2"	1	5

LR COMBO



ITEM CODE	TRADE SIZE	INNER CASE	MASTER CASE
LRC50-CG	1/2"	10	100
LRC75-CG	3/4"	10	50
LRC100-CG	1"	5	25
LRC125-CG	1 1/4"	2	10
LRC150-CG	1 1/2"	2	10
LRC200-CG	2"	1	5

F
I
T
T
I
N
G
S

"America's Electricity Runs On Flexotek"



5361 Preston Ct • Brooklyn, NY 11234 • Tel. 718-257-9300 • Fax. 718-257-9303 • 1 866-4FLEXOTEK • www.flexotek.com

ALUMINUM DIE CAST CONDUIT BODIES

COMBINATION FITTINGS - SET SCREW RIGID



T COMBO

COVERS AND GASKETS ATTACHED



ITEM CODE	TRADE SIZE	INNER CASE	MASTER CASE
TC50-CG	1/2"	10	100
TC75-CG	3/4"	10	50
TC100-CG	1"	5	25
TC125-CG	1 1/4"	2	10
TC150-CG	1 1/2"	2	10
TC200-CG	2"	1	5

C COMBO



ITEM CODE	TRADE SIZE	INNER CASE	MASTER CASE
CC50-CG	1/2"	10	100
CC75-CG	3/4"	10	50
CC100-CG	1"	5	25
CC125-CG	1 1/4"	2	10
CC150-CG	1 1/2"	2	10
CC200-CG	2"	1	5

F
I
T
T
I
N
G
S

"America's Electricity Runs On Flexotek"

ALUMINUM DIE CAST CONDUIT BODIES

SET SCREW



LB SERIES



ITEM CODE	TRADE SIZE	INNER CASE	MASTER CASE
LBSS50	1/2"	10	100
LBSS75	3/4"	10	50
LBSS100	1"	5	25
LBSS125	1 1/4"	2	10
LBSS150	1 1/2"	2	10
LBSS200	2"	1	5
LBSS250	2 1/2"	-	1
LBSS300	3"	-	1
LBSS350	3 1/2"	-	1
LBSS400	4"	-	1

LL SERIES



ITEM CODE	TRADE SIZE	INNER CASE	MASTER CASE
LLSS50	1/2"	10	100
LLSS75	3/4"	10	50
LLSS100	1"	5	25
LLSS125	1 1/4"	2	10
LLSS150	1 1/2"	2	10
LLSS200	2"	1	5
LLSS250	2 1/2"	-	1
LLSS300	3"	-	1
LLSS350	3 1/2"	-	1
LLSS400	4"	-	1

LR SERIES



ITEM CODE	TRADE SIZE	INNER CASE	MASTER CASE
LRSS50	1/2"	10	100
LRSS75	3/4"	10	50
LRSS100	1"	5	25
LRSS125	1 1/4"	2	10
LRSS150	1 1/2"	2	10
LRSS200	2"	1	5
LRSS250	2 1/2"	-	1
LRSS300	3"	-	1
LRSS350	3 1/2"	-	1
LRSS400	4"	-	1

FITTINGS

ALUMINUM DIE CAST CONDUIT BODIES SET SCREW

T SERIES



ITEM CODE	TRADE SIZE	INNER CASE	MASTER CASE
TSS50	1/2"	10	100
TSS75	3/4"	10	50
TSS100	1"	5	25
TSS125	1 1/4"	2	10
TSS150	1 1/2"	2	10
TSS200	2"	1	5
TSS250	2 1/2"	-	1
TSS300	3"	-	1
TSS350	3 1/2"	-	1
TSS400	4"	-	1

C SERIES



ITEM CODE	TRADE SIZE	INNER CASE	MASTER CASE
CSS50	1/2"	10	100
CSS75	3/4"	10	50
CSS100	1"	5	25
CSS125	1 1/4"	2	10
CSS150	1 1/2"	2	10
CSS200	2"	1	5
CSS250	2 1/2"	-	1
CSS300	3"	-	1
CSS350	3 1/2"	-	1
CSS400	4"	-	1



FITTINGS

CONDUIT COVERS WITH SCREWS



DIE CAST ALUMINUM



ITEM CODE	TRADE SIZE	INNER CASE	MASTER CASE
AC50	1/2"	25	250
AC75	3/4"	25	250
AC100	1"	25	250
AC125-100	1 1/4" - 1 1/2"	25	50
AC200	2"	25	50
AC250-300	2 1/2" - 3"	-	10
AC350-400	3 1/2" - 4"	-	10

STEEL



ITEM CODE	TRADE SIZE	INNER CASE	MASTER CASE
SC50	1/2"	25	250
SC75	3/4"	25	250
SC100	1"	25	250
SC125-150	1 1/4" - 1 1/2"	25	50
SC200	2"	25	50

NEOPRENE GASKETS



ITEM CODE	TRADE SIZE	INNER CASE	MASTER CASE
NG50	1/2"	50	1500
NG75	3/4"	50	1250
NG100	1"	50	1000
NG125-150	1 1/4" - 1 1/2"	50	500
NG200	2"	50	200
NG250-300	2 1/2" - 3"	25	100
NG350-400	3 1/2" - 4"	25	100

CONDUIT COVERS



5361 Preston Ct • Brooklyn, NY 11234 • Tel. 718-257-9300 • Fax. 718-257-9303 • 1 866-4FLEXOTEK • www.flexotek.com

UL STEEL FLEXIBLE CONDUIT

GREENFIELD



R= REEL

ITEM CODE	TRADE SIZE	INNER CASE	FT PER COIL/ REEL
UL GFD38-100	3/8"	-	100
UL GFD38-250	3/8"	-	250
UL GFD38R-1000	3/8"	-	1000
UL GFD50-100	1/2"	-	100
UL GFD50R-1000	1/2"	-	1000
UL GFD75-100	3/4"	-	100
UL GFD75R-500	3/4"	-	500
UL GFD100-50	1"	-	50
UL GFD100R-400	1"	-	400
UL GFD125-50	1 1/4"	-	50
UL GFD125R-200	1 1/4"	-	200
UL GFD150-25	1 1/2"	-	25
UL GFD150R-100	1 1/2"	-	100
UL GFD200-25	2"	-	25
UL GFD200R-100	2"	-	100
UL GFD250-25	2 1/2"	-	25
UL GFD300-25	3"	-	25
UL GFD350-25	3 1/2"	-	25
UL GFD400-25	4"	-	25



FLEXIBLE CONDUIT

"America's Electricity Runs On Flexotek"



LIQUID TIGHT FLEXIBLE CONDUIT

SEAL TIGHT CONDUIT (METAL INSIDE)

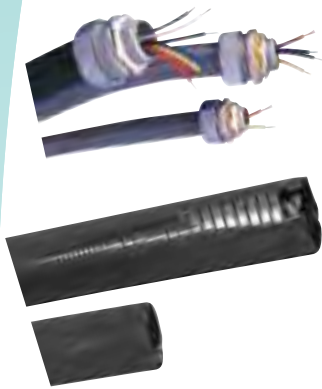

R= REEL

ITEM CODE	TRADE SIZE	INNER CASE	FT PER COIL/ REEL
LT-UL38	3/8"	-	100
LT-UL50	1/2"	-	100
LT-UL50-R	1/2"	-	1000
LT-UL75	3/4"	-	100
LT-UL75-R	3/4"	-	500
LT-UL100	1"	-	100
LT-UL100-R	1"	-	400
LT-UL125	1 1/4"	-	50
LT-UL125-R	1 1/4"	-	250
LT-UL150	1 1/2"	-	50
LT-UL150-R	1 1/2"	-	200
LT-UL200	2"	-	50
LT-UL200-R	2"	-	100
LT-UL250	2 1/2"	-	25
LT-UL300	3"	-	25
LT-UL350	3 1/2"	-	25
LT-UL400	4"	-	25

ITEM	SIZE	INNER DIAMETER		OUTER DIAMETER	
		MIN.	MAX	MIN	MAX
LT-UL38	3/8"	0.483	0.504	0.692	0.714
LT-UL50	1/2"	0.618	0.642	0.819	0.838
LT-UL75	3/4"	0.815	0.839	1.031	1.051
LT-UL100	1"	1.031	1.059	1.287	1.314
LT-UL125	1 1/4"	1.382	1.405	1.633	1.661
LT-UL150	1 1/2"	1.583	1.606	1.866	1.901
LT-UL200	2"	2.008	2.039	2.338	2.374
LT-UL250	2 1/2"	2.461	2.519	2.838	2.874
LT-UL300	3"	3.055	3.102	3.452	3.501
LT-UL350	3 1/2"	3.524	3.562	3.956	3.996
LT-UL400	4"	3.981	4.035	4.456	4.501

FLEXIBLE LIQUID TIGHT CONDUIT

"America's Electricity Runs On Flexotek"



5361 Preston Ct • Brooklyn, NY 11234 • Tel. 718-257-9300 • Fax. 718-257-9303 • 1 866-4FLEXOTEK • www.flexotek.com

NON METALLIC LIQUID TIGHT



LIQUID TIGHT CONDUIT (UL)

ITEM CODE	TRADE SIZE	INNER CASE	FT PER COIL/ REEL
LTNM-38	3/8"	-	100
LTNM-50	1/2"	-	100
LTNM-75	3/4"	-	100
LTNM100	1"	-	100
LTNM125	1 1/4"	-	100
LTNM150	1 1/2'	-	50
LTNM200	2"	-	50
LTNM50R	1/2"	-	500
LTNM75R	3/4"	-	500
LTNM100R	1"	-	500

R= REEL

I



FLEXIBLE LIQUID TIGHT CONDUIT

"America's Electricity Runs On Flexotek"

BX- FLEX DIE CAST FITTINGS



2 SCREW CLAMP CONNECTOR (Romex connector)



ITEM CODE	TRADE SIZE	INNER CASE	MASTER CASE
395	3/8" - 1/2" ko	100	1000



613	1/2"	100	1000
-----	------	-----	------

SADDLE TYPE CONNECTOR



ITEM CODE	TRADE SIZE	INNER CASE	MASTER CASE
180	3/8" - 1/2" ko	50	500

BX CONNECTOR



ITEM CODE	TRADE SIZE	INNER CASE	MASTER CASE
280	3/8"	100	1000

DUPLEX 1 SCREW CLAMP TYPE CONNECTOR



ITEM CODE	TRADE SIZE	INNER CASE	MASTER CASE
380	3/8"	25	250

DUPLEX 1 SCREW CONNECTOR



ITEM CODE	TRADE SIZE	INNER CASE	MASTER CASE
480	3/8"	25	250

B

X

/

F

L

E

X

NM AND SE CABLE FITTINGS



ITEM CODE	TRADE SIZE	INNER CASE	MASTER CASE
SERN07	3/4"	250	250
SERN10	1"	10	100
SERN12	1 1/4"	10	100
SERN15	1 1/2"	5	50
SERN20	2"	4	40

**N
M
-
S
E
C
A
B
L
E**

"America's Electricity Runs On Flexotek"

FLEX FITTINGS

ZINC DIE CAST

EMT TO BX OR NM SET SCREW TO CLAMP TYPE



ITEM CODE	TRADE SIZE	INNER CASE	MASTER CASE
EMT BX/NM	1/2" - 3/8"	50	500

EMT TO FLEX SET SCREW TO CLAMP TYPE



ITEM CODE	TRADE SIZE	INNER CASE	MASTER CASE
EMT-FLEX 50	1/2" - 1/2"	25	250
EMT-FLEX 75	3/4" - 3/4"	20	200
EMT-FLEX 100	1" - 1"	10	100

EMT TO BX SET SCREW TYPE



ITEM CODE	TRADE SIZE	INNER CASE	MASTER CASE
EMT-BX	1/2" - 3/8"	50	500

EMT TO FLEX SET SCREW TYPE



ITEM CODE	TRADE SIZE	INNER CASE	MASTER CASE
EMT-FLEX 50	1/2"	25	250
EMT-FLEX 75	3/4"	20	200
EMT-FLEX 100	1"	10	100
EMT-FLEX 125	1 1/4"	10	100
EMT-FLEX 150	1 1/2"	5	50
EMT-FLEX 200	2"	4	40

FLEX FITTINGS



BX-FLEX CONNECTORS SQUEEZE TYPE

ZINC DIE CAST

STRAIGHT



ITEM CODE	TRADE SIZE	INNER CASE	MASTER CASE
GFDCS38	3/8"	50	500
GFDCS50	1/2"	25	250
GFDCS75	3/4"	25	250
GFDCS100	1"	10	100
GFDCS125	1 1/4"	10	100
GFDCS150	1 1/2"	5	50
GFDCS200	2"	10	40
GFDCS250	2 1/2"	-	10
GFDCS300	3"	-	10
GFDCS350	3 1/2"	-	1
GFDCS400	4"	-	1

90 DEGREES



ITEM CODE	TRADE SIZE	INNER CASE	MASTER CASE
GFDCS38	3/8"		50/500
GFDCS50	1/2"		25/250
GFDCS75	3/4"		25/250
GFDCS100	1"		10/100
GFDCS125	1 1/4"		5/50
GFDCS150	1 1/2"		5/50
GFDCS200	2"		5/50
GFDCS250	2 1/2"		5
GFDCS300	3"		2
GFDCS350	3 1/2"		1
GFDCS400	4"		1

BX / FLEX
CONNECTORS

BX-FLEX CONNECTORS SQUEEZE TYPE



MALLEABLE IRON

STRAIGHT



ITEM CODE	TRADE SIZE	INNER CASE	MASTER CASE
GFDCS38-M	3/8"	50	500
GFDCS50-M	1/2"	25	250
GFDCS75-M	3/4"	25	250
GFDCS100-M	1"	10	100
GFDCS125-M	1 1/4"	10	100
GFDCS150-M	1 1/2"	5	50
GFDCS200-M	2"	10	40
GFDCS250-M	2 1/2"	-	10
GFDCS300-M	3"	-	10
GFDCS350-M	3 1/2"	-	1
GFDCS400-M	4"	-	1

90 DEGREES



ITEM CODE	TRADE SIZE	INNER CASE	MASTER CASE
GFDCS38-M	3/8"	50	500
GFDCS50-M	1/2"	25	250
GFDCS75-M	3/4"	25	250
GFDCS100-M	1"	10	100
GFDCS125-M	1 1/4"	5	50
GFDCS150-M	1 1/2"	5	50
GFDCS200-M	2"	5	50
GFDCS250-M	2 1/2"	-	5
GFDCS300-M	3"	-	2
GFDCS350-M	3 1/2"	-	1
GFDCS400-M	4"	-	1

BX-FLEX CONNECTORS

"America's Electricity Runs On Flexotek"

LIQUID TIGHT CONNECTORS

ZINC DIE CAST



STRAIGHT



ITEM CODE	TRADE SIZE	INNER CASE	MASTER CASE
LTCS38	3/8"	50	200
LTCS50	1/2"	50	200
LTCS75	3/4"	25	100
LTCS100	1"	-	10
LTCS125	1 1/4"	-	10
LTCS150	1 1/2"	-	5
LTCS200	2"	-	5
LTCS250	2 1/2"	-	1
LTCS300	3"	-	1
LTCS350	3 1/2"	-	1
LTCS400	4"	-	1

90 DEGREES



ITEM CODE	TRADE SIZE	INNER CASE	MASTER CASE
LTCC38	3/8"	50	200
LTCC50	1/2"	50	200
LTCC75	3/4"	25	100
LTCC100	1"	-	10
LTCC125	1 1/4"	-	10
LTCC150	1 1/2"	-	5
LTCC200	2"	-	5
LTCC250	2 1/2"	-	1
LTCC300	3"	-	1
LTCC350	3 1/2"	-	1
LTCC400	4"	-	1

L
I
Q
U
I
D
T
I
G
H
T

"America's Electricity Runs On Flexotek"

LIQUID TIGHT CONNECTORS INSULATED MALLEABLE IRON



STRAIGHT



ITEM CODE	TRADE SIZE	INNER CASE	MASTER CASE
LTCS38- IM	3/8"	50	200
LTCS50- IM	1/2"	50	200
LTCS75- IM	3/4"	25	100
LTCS100- IM	1"	10	10
LTCS125- IM	1 1/4"	10	10
LTCS150- IM	1 1/2"	-	5
LTCS200- IM	2"	-	5
LTCS250- IM	2 1/2"	-	1
LTCS300- IM	3"	-	1
LTCS350- IM	3 1/2"	-	1
LTCS400- IM	4"	-	1

45 DEGREES



ITEM CODE	TRADE SIZE	INNER CASE	MASTER CASE
LTC45(38)- IM	3/8"	-	25
LTC45(50)- IM	1/2"	-	25
LTC45(75)- IM	3/4"	-	25
LTC45(100)- IM	1"	-	10
LTC45(125)- IM	1 1/4"	-	10
LTC45(150)- IM	1 1/2"	-	5
LTC45(200)-IM	2"	-	5
LTC45(250)- IM	2 1/2"	-	1
LTC45(300)- IM	3"	-	1
LTC45(350)- IM	3 1/2"	-	1
LTC45(400)- IM	4"	-	1

90 DEGREES



ITEM CODE	TRADE SIZE	INNER CASE	MASTER CASE
LTCC38- IM	3/8"	25	100
LTCC50- IM	1/2"	25	100
LTCC75- IM	3/4"	25	100
LTCC100- IM	1"	-	10
LTCC125- IM	1 1/4"	-	10
LTCC150- IM	1 1/2"	-	5
LTCC200- IM	2"	-	5
LTCC250- IM	2 1/2"	-	1
LTCC300- IM	3"	-	1
LTCC350- IM	3 1/2"	-	1
LTCC400- IM	4"	-	1

L
I
Q
U
I
D
T
I
G
H
T

"America's Electricity Runs On Flexotek"

LIQUID TIGHT CONNECTORS

NON METALLIC



STRAIGHT



ITEM CODE	TRADE SIZE	INNER CASE	MASTER CASE
LTNMCS38	3/8"	25	100
LTNMCS50	1/2"	25	100
LTNMCS75	3/4"	10	100
LTNMCS100	1"	5	50
LTNMCS125	1 1/4"	5	25
LTNMCS150	1 1/2"	2	10
LTNMCS200	2"	2	10

90 DEGREES



ITEM CODE	TRADE SIZE	INNER CASE	MASTER CASE
LTNMCC38	3/8"	10	100
LTNMCC50	1/2"	10	100
LTNMCC75	3/4"	10	100
LTNMCC100	1"	5	50
LTNMCC125	1 1/4"	5	25
LTNMCC150	1 1/2"	2	10
LTNMCC200	2"	2	10

L
I
Q
U
I
D
T
I
G
H
T

"America's Electricity Runs On Flexotek"

WATER TIGHT HUBS - SEALING LOCKNUTS- KO SEALS



SEALING LOCKNUTS



ITEM CODE	TRADE SIZE	INNER CASE	MASTER CASE
SLKNS50	1/2"	50	500
SLKNS75	3/4"	50	500
SLKNS100	1"	25	250
SLKNS125	1 1/4"	10	100
SLKNS150	1 1/2"	10	100
SLKNS200	2"	10	100
SLKNS250	2 1/2"	-	25
SLKNS300	3"	-	25
SLKNS350	3 1/2"	-	25
SLKNS400	4"	-	25

WATER TIGHT HUBS



ITEM CODE	TRADE SIZE	INNER CASE	MASTER CASE
WHUB50	1/2"	25	250
WHUBS75	3/4"	10	100
WHUBS100	1"	10	100
WHUBS125	1 1/4"	2	20
WHUBS150	1 1/2"	2	20
WHUBS200	2"	2	20
WHUBS250	2 1/2"	-	2
WHUBS300	3"	-	2
WHUBS350	3 1/2"	-	2
WHUBS400	4"	-	2

KO SEALS



ITEM CODE	TRADE SIZE	INNER CASE	MASTER CASE
KOS50	1/2"	100	1000
KOS75	3/4"	100	1000
KOS100	1"	50	500
KOS125	1 1/4"	50	500
KOS150	1 1/2"	50	500
KOS200	2"	10	100

HUBS & LOCKNUTS

"America's Electricity Runs On Flexotek"



5361 Preston Ct • Brooklyn, NY 11234 • Tel. 718-257-9300 • Fax. 718-257-9303 • 1 866-4FLEXOTEK • www.flexotek.com

MALLEABLE IRON WATER TIGHT HUBS



ITEM CODE	TRADE SIZE	INNER CASE	MASTER CASE
WHUB50	1/2"	25	250
WHUBS75	3/4"	10	100
WHUBS100	1"	10	100
WHUBS125	1 1/4"	2	20
WHUBS150	1 1/2"	2	20
WHUBS200	2"	2	20
WHUBS250	2 1/2"	-	2
WHUBS300	3"	-	2
WHUBS350	3 1/2"	-	2
WHUBS400	4"	-	2



DUPLEX BX 90 CONNECTOR



ITEM CODE	TRADE SIZE	INNER CASE	MASTER CASE
DUPLEX BX 90	3/8"	25	250

DOUBLE BITE SADDLE CONNECTORS INSULATED STEEL



ITEM CODE	TRADE SIZE	INNER CASE	MASTER CASE
DBC38	3/8"	25	250
DBC50	1/2"	10	100
DBC75	3/4"	10	100
DBC100	1"	2	20
DBC125	1 1/4"	2	20
DCB150	1 1/2"	2	20
DCB200	2"	2	10

DOUBLE BITE SADDLE CONNECTORS INSULATED STEEL-90 DEGREE



ITEM CODE	TRADE SIZE	INNER CASE	MASTER CASE
DCB38-90	1/2"	25	250
DBC50-90	3/4"	10	100
DBC100-90	1"	10	100
DBC125-90	1 1/4"	2	20
DBC150-90	1 1/2"	2	20
DBC200-90	2"	2	20

**HUBS
&
SADDLES
&
SADDLES**

"America's Electricity Runs On Flexotek"

STEEL LOCKNUTS

GROUNDING LOCKNUTS



ITEM CODE	TRADE SIZE	INNER CASE	MASTER CASE
LKNSGR50	1/2"	100	1000
LKNSGR75	3/4"	100	1000
LKNSGR100	1"	50	500
LKNSGR125	1 1/4"	50	500
LKNSGR150	1 1/2"	25	250
LKNSGR200	2"	20	200
LKNSGR250	2 1/2"	-	25
LKNSGR300	3"	-	25
LKNSGR350	3 1/2"	-	25
LKNSGR400	4"	-	25

RIGID CONDUIT LOCKNUTS



ITEM CODE	TRADE SIZE	INNER CASE	MASTER CASE
LKNS50	1/2"	100	2000
LKNS75	3/4"	100	1000
LKNS100	1"	100	1000
LKNS125	1 1/4"	50	500
LKNS150	1 1/2"	50	500
LKNS200	2"	25	25
LKNS250	2 1/2"	-	25
LKNS300	3"	-	25
LKNS350	3 1/2"	-	25
LKNS400	4"	-	25
LKNS500	5"	-	10
LKNS600	6"	-	10

L
O
C
K
N
U
T
S

EMT FITTINGS STEEL



SET SCREW CONNECTORS EMT & RIGID



ITEM CODE	TRADE SIZE	INNER CASE	MASTER CASE
SCON50-S	1/2"	50	500
SCON75-S	3/4"	25	250
SCON100-S	1"	50	200
SCON125-S	1 1/4"	-	25
SCON150-S	1 1/2"	-	25
SCON200-S	2"	-	20
SCON250-S*	2 1/2"	-	12
SCON300-S*	3"	-	12
SCON350-S*	3 1/2"	-	6
SCON400-S*	4"	-	6

SET SCREW COUPLINGS EMT & RIGID



ITEM CODE	TRADE SIZE	INNER CASE	MASTER CASE
SCOUP50-S	1/2"	50	500
SCOUP75-S	3/4"	25	250
SCOUP100-S	1"	10	100
SCOUP125-S	1 1/4"	-	25
SCOUP150-S	1 1/2"	-	25
SCOUP200-S	2"	-	20
SCOUP250-S*	2 1/2"	-	12
SCOUP300-S*	3"	-	12
SCOUP350-S*	3 1/2"	-	6
SCOUP400-S*	4"	-	6

***EMT & RIGID**

FOR INSULATED FITTINGS JUST ADD - "IS" TO CATALOG #

E
M
T
F
I
T
T
I
N
G
S

"America's Electricity Runs On Flexotek"

EMT FITTINGS ZINC



SET SCREW CONNECTORS EMT



ITEM CODE	TRADE SIZE	INNER CASE	MASTER CASE
SSCON50-DC	1/2"	50	500
SSCON75-DC	3/4"	25	250
SSCON100-DC	1"	50	200
SSCON125-DC	1 1/4"	-	25
SSCON150-DC	1 1/2"	-	25
SSCON200-DC	2"	-	20
SSCON250-DC	2 1/2"	-	12
SSCON300-DC	3"	-	12
SSCON350-DC	3 1/2"	-	6
SSCON400-DC	4"	-	6

SET SCREW COUPLINGS EMT



ITEM CODE	TRADE SIZE	INNER CASE	MASTER CASE
SSCOUP50-DC	1/2"	50	500
SSCOUP75-DC	3/4"	25	250
SSCOUP100-DC	1"	10	100
SSCOUP125-DC	1 1/4"	-	25
SSCOUP150-DC	1 1/2"	-	25
SSCOUP200-DC	2"	-	20
SSCOUP250-DC	2 1/2"	-	12
SSCOUP300-DC	3"	-	12
SSCOUP350-DC	3 1/2"	-	6
SSCOUP400-DC	4"	-	6

FOR INSULATED FITTINGS JUST ADD - "IS" TO CATALOG #

E
M
T

F
I
T
T
I
N
G
S

EMT FITTINGS STEEL



COMPRESSION CONNECTORS EMT



ITEM CODE	TRADE SIZE	INNER CASE	MASTER CASE
C-CON50/S	1/2"	25	250
C-CON75/S	3/4"	25	250
C-CON100/S	1"	10	100
C-CON125/S	1 1/4"	-	25
C-CON150/S	1 1/2"	-	20
C-CON200/S	2"	-	15
C-CON250/S	2 1/2"	-	12
C-CON300/S	3"	-	12
C-CON350/S	3 1/2"	-	6
C-CON400/S	4"	-	6

COMPRESSION COUPLINGS EMT



ITEM CODE	TRADE SIZE	INNER CASE	MASTER CASE
C-COUP50/S	1/2"	25	250
C-COUP75/S	3/4"	25	250
C-COUP100/S	1"	10	100
C-COUP125/S	1 1/4"	-	25
C-COUP150/S	1 1/2"	-	20
C-COUP200/S	2"	-	15
C-COUP250/S	2 1/2"	-	12
C-COUP300/S	3"	-	12
C-COUP350/S	3 1/2"	-	6
C-COUP400/S	4"	-	6

FOR INSULATED FITTINGS JUST ADD - "IS" TO CATALOG #

E
M
T
F
I
T
T
I
N
G
S

"America's Electricity Runs On Flexotek"

RIGID CONDUIT NIPPLES

ZINC DIE CAST



CHASE NIPPLES



ITEM CODE	TRADE SIZE	INNER CASE	MASTER CASE
CN50	1/2"	100	1000
CN75	3/4"	50	500
CN100	1"	25	250
CN125	1 1/4"	25	250
CN150	1 1/2"	10	100
CN200	2"	10	100
CN250	2 1/2"	-	5
CN300	3"	-	5
CN350	3 1/2"	-	5
CN400	4"	-	5

OFF SET NIPPLES



ITEM CODE	TRADE SIZE	INNER CASE	MASTER CASE
OFN50	1/2"	10	100
OFN75	3/4"	10	100
OFN100	1"	10	100
OFN125	1 1/4"	5	50
OFN150	1 1/2"	5	50
OFN200	2"	4	40
OFN250	2 1/2"	-	1
OFN300	3"	-	1

S E L P - N - T - C D N O C

"America's Electricity Runs On Flexotek"

CONDUIT SUPPORT



CLAMP BACKS EMT / RIGID MALLEABLE IRON

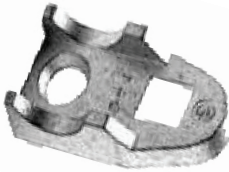

ITEM CODE	TRADE SIZE	INNER CASE	MASTER CASE
CLAMPBACK50	1/2"	25	250
CLAMPBACK75	3/4"	25	250
CLAMPBACK100	1"	25	250
CLAMPBACK125	1 1/4"	10	100
CLAMPBACK150	1 1/2"	10	100
CLAMPBACK200	2"	5	50
CLAMPBACK250	2 1/2"	-	25
CLAMPBACK300	3"	-	10
CLAMPBACK350	3 1/2"	-	10
CLAMPBACK400	4"	-	10

RIGID STRAPS MALLEABLE IRON



ITEM CODE	TRADE SIZE	INNER CASE	MASTER CASE
R STRAP50- MI	1/2"	10	100
R STRAP75- MI	3/4"	10	50
R STRAP100- MI	1"	5	25
R STRAP125- MI	1 1/4"	2	10
R STRAP150- MI	1 1/2"	2	10
R STRAP200- MI	2"	1	5
R STRAP250- MI	2 1/2"	-	1
R STRAP300- MI	3"	-	1
R STRAP350- MI	3 1/2"	-	1
R STRAP400- MI	4"	-	1

CONDUIT SUPPORT

"America's Electricity Runs On Flexotek"

CONDUIT SUPPORT



BX STRAP STEEL



ITEM CODE	CABLE RANGE	INNER CASE	MASTER CASE
BX STRAP	14/2 - 10/3	100	1000

STAPLES FOR NMC AND ARMORED 3 WIRE #14 - #12 - #10

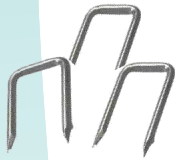

ITEM CODE	SIZE	INNER CASE	MASTER CASE
STAPLES 3 W (100 ct)	9/16" x 1 1/4"	100	5000
STAPLES 3 W (500 ct)	9/16" x 1 1/4"	500	5000

BEAM CLAMP -- MALLEABLE IRON



ITEM CODE	TRADE SIZE	INNER CASE	MASTER CASE
BCLAMP 1/4"-20	1"	-	50
BCLAMP 3/8"-16	2"	-	25
BCLAMP 1/2"-13	2 1/2"	-	25

CONDUIT SUPPORT

CONDUIT SUPPORT



STRUT CLAMP UNIVERSAL SELF THREADING



ITEM CODE	TRADE SIZE	INNER CASE	MASTER CASE
STRUTCLAMP50	1/2"	-	100
STRUTCLAMP75	3/4"	-	100
STRUTCLAMP100	1"	-	100
STRUTCLAMP125	1 1/4"	-	100
STRUTCLAMP150	1 1/2"	-	50
STRUTCLAMP200	2"	-	50
STRUTCLAMP250	2 1/2"	-	50
STRUTCLAMP300	3"	-	25
STRUTCLAMP350	3 1/2"	-	25
STRUTCLAMP400	4"	-	25

CONDUIT HANGER WITH BOLT AND NUT



ITEM CODE	EMT CONDUIT	RIGID CONDUIT	MASTER CASE
C HANGER #0	1/2"	3/8" - 1/2"	100
C HANGER #1	3/4"	3/4"	100
C HANGER #2	1"	1"	100
C HANGER #2 1/2"	1 1/4"	-	100
C HANGER #3	1 1/2"	1 1/4"	100
C HANGER #4	-	1 1/2"	100
C HANGER #5	2"	2"	50
C HANGER #6	2 1/2"	2 1/2"	50
C HANGER #7	3"	3"	25
C HANGER #8	3 1/2"	3 1/2"	25
C HANGER #9	4"	4"	25

CONDUIT SUPPORT

"America's Electricity Runs On Flexotek"

STEEL STRAPS



EMT STRAPS 1 HOLE SNAP ON STYLE



ITEM CODE	TRADE SIZE	INNER CASE	MASTER CASE
EMTSTRAP50-1H	1/2"	100	1000
EMTSTRAP75-1H	3/4"	100	1000
EMTSTRAP100-1H	1"	50	500
EMTSTRAP125-1H	1 1/4"	25	250
EMTSTRAP150-1H	1 1/2"	10	100
EMTSTRAP200-1H	2"	10	100
STRAP250-1H**	2 1/2"	-	50
STRAP300-1H**	3"	-	25
STRAP350-1H**	3 1/2"	-	25
STRAP400-1H**	4"	-	25

** EMT AND RIGID



EMT STRAPS 2 HOLE SNAP ON STYLE



ITEM CODE	TRADE SIZE	INNER CASE	MASTER CASE
EMTSTRAP50-2H	1/2"	50	500
EMTSTRAP75-2H	3/4"	50	500
EMTSTRAP100-2H	1"	50	500
EMTSTRAP125-2H	1 1/4"	20	200
EMTSTRAP150-2H	1 1/2"	20	200
EMTSTRAP200-2H	2"	10	50
STRAP250-2H**	2 1/2"	-	25
STRAP300-2H**	3"	-	25
STRAP350-2H**	3 1/2"	-	25
STRAP400-2H**	4"	-	25

** EMT AND RIGID

P
I
P
E

S
T
R
A
P
S

"America's Electricity Runs On Flexotek"

STEEL STRAPS

RIGID STRAPS 1 HOLE



ITEM CODE	TRADE SIZE	INNER CASE	MASTER CASE
RIGIDSTRAP50-1H	1/2"	50	500
RIGIDSTRAP75-1H	3/4"	50	500
RIGIDSTRAP100-1H	1"	25	250
RIGIDSTRAP125-1H	1 1/4"	20	200
RIGIDSTRAP150-1H	1 1/2"	20	200
RIGIDSTRAP200-1H	2"	10	100
STRAP250-1H**	2 1/2"	-	50
STRAP300-1H**	3"	-	25
STRAP350-1H**	3 1/2"	-	25
STRAP400-1H**	4"	-	25

** EMT AND RIGID

RIGID STRAPS 2 HOLE



ITEM CODE	TRADE SIZE	INNER CASE	MASTER CASE
RIGIDSTRAP50-2H	1/2"	50	500
RIGIDSTRAP75-2H	3/4"	50	500
RIGIDSTRAP100-2H	1"	25	250
RIGIDSTRAP125-2H	1 1/4"	20	200
RIGIDSTRAP150-2H	1 1/2"	10	100
RIGIDSTRAP200-2H	2"	10	50
STRAP250-2H**	2 1/2"	-	25
STRAP300-2H**	3"	-	25
STRAP350-2H**	3 1/2"	-	25
STRAP400-2H**	4"	-	25

** EMT AND RIGID

P
I
P
E
S
T
R
A
P
S

"America's Electricity Runs On Flexotek"

NYLON PRODUCTS



PLASTIC BUSHINGS



ITEM CODE	TRADE SIZE	INNER CASE	MASTER CASE
PB50	1/2"	100	1000
PB75	3/4"	100	1000
PB100	1"	50	500
PB125	1 1/4"	25	250
PB150	1 1/2"	25	250
PB200	2"	20	200
PB250	2 1/2"	20	100
PB300	3"	-	20
PB350	3 1/2"	-	10
PB400	4"	-	10
PB500	5"	-	5
PB600	6"	-	5

ANTI SHORT BUSHINGS



ITEM CODE	TRADE SIZE	INNER CASE	MASTER CASE
ASB-0	5/16"	35	100
ASB-1	3/8"	35	100
ASB-2	7/16"	35	100
ASB-3	1/2"	20	100
ASB-4	3/4"	16	100
ASB-5	1"	16	100

STUD BUSHING



ITEM CODE	TRADE SIZE	INNER CASE	MASTER CASE
SSB	UNIVERSAL	-	25

NYLON PRODUCTS

TEMPORARY LIGHTING ACCESSORIES

PIGTAIL SOCKET



ITEM CODE	ITEM DESCRIPTION	INNER CASE	MASTER CASE
RUPGR	RIGHT HAND RUBBER	10	250
RUPGL	LEFT HAND RUBBER	10	250
BKRPG	RIGHT HAND BAKELITE	10	250

PLASTIC CAGES



ITEM CODE	ITEM DESCRIPTION	INNER CASE	MASTER CASE
RCG	BIRD CAGES	5	100

HEAVY DUTY PROTECTIVE PLASTIC CAGES DOUBLE SNAP - LOCK MECHANISM



LIGHT STRINGERS

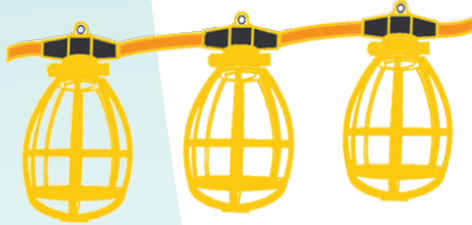

ITEM CODE	ITEM DESCRIPTION	INNER CASE	MASTER CASE
DSTR-100	STRINGERS	-	1

CENTERED SOCKETS (10FT)
MOLDED 14/2 CORD 10 HEAVY DUTY CAGES INCLUDED
MALE PLUG / END CAP

DSTR-143	STRINGERS	-	1
----------	-----------	---	---

DELUXE MODEL CENTERED SOCKETS (10FT)
MOLDED 14/3 CORD 10 HEAVY DUTY CAGES INCLUDED
MALE PLUG - FEMALE END

T
E
M
P
O
R
A
R
Y

L
I
G
H
T
I
N
G

GROUNDING GREEN PIGTAILS - GROUNDING SCREW

GREEN GROUNDING PIGTAIL

ITEM CODE	TRADE SIZE	INNER CASE	MASTER CASE
-----------	------------	------------	-------------

GRPT	7 1/2"	100	1000
------	--------	-----	------

12ga SOLID

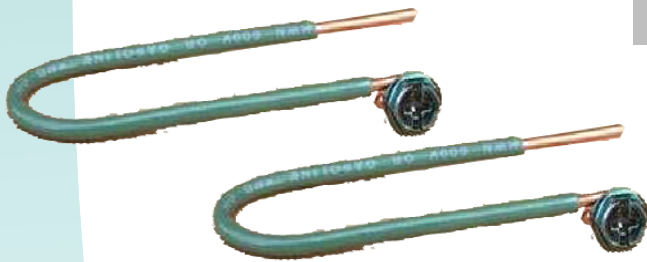

GREEN SCREW FOR GROUNDING

ITEM CODE	TRADE SIZE	INNER CASE	MASTER CASE
-----------	------------	------------	-------------

GR-SCREW	10/32" x 3/8"	200	2000
----------	---------------	-----	------



**G
R
O
U
N
D
I
N
G**

"America's Electricity Runs On Flexotek"

ACCESSORIES

VICTOR SPLIT KNOBS GLAZED PORCELAIN INSULATORS



ITEM CODE	TRADE SIZE	INNER CASE	MASTER CASE
VS22	1 "	-	100
VS38	1 1/2"	-	50

APPLIANCE CORDS (LAUNDRY DROPS)



ITEM CODE	ITEM DESCRIPTION	INNER CASE	MASTER CASE
FLD36	FEMALE PLUG	10	50
36" LONG SJTW 16 AWG HIGH TEMPERATURE 105°			
MLD72	MALE PLUG	10	50
72" LONG SJT 16 AWG HIGH TEMPERATURE 105°			
MLD 36	MALE PLUG	10	100
36" LONG SJT 16 AWGT HIGH TEMPERATURE 105			

FIXTURE CHAIN



ITEM CODE	TRADE SIZE	INNER CASE	MASTER CASE
FCHAIN 100	1 YARD	10	100

JACK CHAIN



ITEM CODE	FEET EACH	INNER CASE Ga	MASTER CASE
JACK CHAIN 12-100	100ft	12	4

BLACK ANNEALED WIRE 16GA TIE WIRE



ITEM CODE	WEIGHT PER ROLL	INNER CASE	MASTER CASE
TIE WIRE 3.5	3.5 LBS	-	10

A
C
C
E
S
S
O
R
I
E
S



5361 Preston Ct • Brooklyn, NY 11234 • Tel. 718-257-9300 • Fax. 718-257-9303 • 1 866-4FLEXOTEK • www.flexotek.com

CONDUIT NIPPLES GALVANIZED STEEL



STEEL NIPPLES



ITEM CODE	CONDUIT SIZE	LENGTH	QTY / CASE
N50-CL	1/2"	CLOSE	25
N50-150	1/2"	1 1/2"	25
N50-200	1/2"	2"	25
N50-250	1/2"	2 1/2"	25
N50-300	1/2"	3"	25
N50-350	1/2"	3 1/2"	25
N50-400	1/2"	4"	25
N50-500	1/2"	5"	25
N50-600	1/2"	6"	25
N50-800	1/2"	8"	25
N50-1000	1/2"	10"	25
N50-1200	1/2"	12"	25

ITEM CODE	CONDUIT SIZE	LENGTH	QTY / CASE
N75-CL	3/4"	CLOSE	25
N75-150	3/4"	1 1/2"	25
N75-200	3/4"	2"	25
N75-250	3/4"	2 1/2"	25
N75-300	3/4"	3"	25
N75-350	3/4"	3 1/2"	25
N75-400	3/4"	4"	25
N75-500	3/4"	5"	25
N75-600	3/4"	6"	25
N75-800	3/4"	8"	25
N75-1000	3/4"	10"	25
N75-1200	3/4"	12"	25

ITEM CODE	CONDUIT SIZE	LENGTH	QTY / CASE
N100-CL	1"	CLOSE	25
N100-200	1"	2"	25
N100-250	1"	2 1/2"	25
N100-300	1"	3"	25
N100-350	1"	3 1/2"	25
N100-400	1"	4"	25
N100-500	1"	5"	25
N100-600	1"	6"	25
N100-800	1"	8"	25
N100-1000	1"	10"	25
N100-1200	1"	12"	25

"America's Electricity Runs On Flexotek"

CONDUIT NIPPLES GALVANIZED STEEL



ITEM CODE	CONDUIT SIZE	LENGTH	QTY / CASE
N125-CL	1 1/4"	CLOSE	25
N125-200	1 1/4"	2"	25
N125-250	1 1/4"	2 1/2"	25
N125-300	1 1/4"	3"	25
N125-350	1 1/4"	3 1/2"	25
N125-400	1 1/4"	4"	25
N125-500	1 1/4"	5"	25
N125-600	1 1/4"	6"	25
N125-800	1 1/4"	8"	25
N125-100	1 1/4"	10"	25
N125-100	1 1/4"	12"	25



TEM CODE	CONDUIT SIZE	LENGTH	QTY / CASE
N150-CL	1 1/2"	CLOSE	25
N150-200	1 1/2"	2"	25
N150-250	1 1/2"	2 1/2"	25
N150-300	1 1/2"	3"	25
N150-350	1 1/2"	3 1/2"	25
N150-400	1 1/2"	4"	25
N150-500	1 1/2"	5"	25
N150-600	1 1/2"	6"	25
N150-800	1 1/2"	8"	25
N150-100	1 1/2"	10"	25
N150-1200	1 1/2"	12"	25



S
T
E
E
L
C
O
N
D
U
I
T
N
I
P
P
L
E
S

"America's Electricity Runs On Flexotek"



5361 Preston Ct • Brooklyn, NY 11234 • Tel. 718-257-9300 • Fax. 718-257-9303 • 1 866-4FLEXOTEK • www.flexotek.com



STEEL PIPE

ITEM CODE	CONDUIT SIZE	LENGTH	QTY / CASE
N200-CL	2"	CLOSE	25
N200-250	2"	2 1/2"	25
N200-300	2"	3"	25
N200-350	2"	3 1/2"	25
N200-400	2"	4"	25
N200-500	2"	5"	25
N200-600	2"	6"	25
N200-800	2"	8"	12
N200-1000	2"	10"	10
N200-1200	2"	12"	10

ITEM CODE	CONDUIT SIZE	LENGTH	QTY / CASE
N250-CL	2 1/2"	CLOSE	10
N250-300	2 1/2"	3"	10
N250-350	2 1/2"	3 1/2"	10
N250-400	2 1/2"	4"	10
N250-500	2 1/2"	5"	10
N250-600	2 1/2"	6"	10
N250-800	2 1/2"	8"	10
N250-1000	2 1/2"	10"	5
N250-1200	2 1/2"	12"	5

ITEM CODE	CONDUIT SIZE	LENGTH	QTY / CASE
N300-CL	3"	CLOSE	10
N300-300	3"	3"	10
N300-350	3"	3 1/2"	10
N300-400	3"	4"	10
N300-500	3"	5"	10
N300-600	3"	6"	10
N300-800	3"	8"	5
N300-1000	3"	10"	5
N300-1200	3"	12"	5

"America's Electricity Runs On Flexotek"



5361 Preston Ct • Brooklyn, NY 11234 • Tel. 718-257-9300 • Fax. 718-257-9303 • 1 866-4FLEXOTEK • www.flexotek.com

CONDUIT NIPPLES

GALVANIZED STEEL



ITEM CODE	CONDUIT SIZE	LENGTH	QTY / CASE
N350-CL	3 1/2"	CLOSE	10
N350-400	3 1/2"	4"	6
N350-500	3 1/2"	5"	6
N350-600	3 1/2"	6"	5
N350-800	3 1/2"	8"	3
N350-1000	3 1/2"	10"	3
N350-1200	3 1/2"	12"	3



ITEM CODE	CONDUIT SIZE	LENGTH	QTY / CASE
N400-CL	4"	CLOSE	10
N400-400	4"	4"	6
N400-500	4"	5"	6
N400-600	4"	6"	5
N400-800	4"	8"	3
N400-1000	4"	10"	3
N400-1200	4"	12"	3



S
T
E
E
L
-
P
I
P
E
S

"America's Electricity Runs On Flexotek"

THREADED CONDUIT COUPLINGS



THREADED CONDUIT COUPLINGS -- STEEL



ITEM CODE	TRADE SIZE	INNER CASE	MASTER CASE
THCP50	1/2"	-	100
THCP75	3/4"	-	50
THCP100	1"	-	30
THCP125	1 1/4"	-	25
THCP150	1 1/2"	-	25
THCP200	2"	-	20
THCP250	2 1/2"	-	24
THCP300	3"	-	16
THCP350	3 1/2"	-	12
THCP400	4"	-	10
THCP500	5"	-	1
THCP600	6"	-	1



CONDUIT COUPLINGS

"America's Electricity Runs On Flexotek"



5361 Preston Ct • Brooklyn, NY 11234 • Tel. 718-257-9300 • Fax. 718-257-9303 • 1 866-4FLEXOTEK • www.flexotek.com

THREADED ELBOWS GALVANIZED STEEL 90°



R
I
G
I
D
E
L
B
O
W
S



ITEM CODE	TRADE SIZE	INNER CASE	MASTER CASE
RGE50-90	1/2"	-	50
RGE75-90	3/4"	-	50
RGE100-90	1"	-	25
RGE125-90	1 1/4"	-	20
RGE150-90	1 1/2"	-	15
RGE200-90	2"	-	10
RGE250-90	2 1/2"	-	1
RGE300-90	3"	-	1
RGE350-90	3 1/2"	-	1
RGE400-90	4"	-	1

45°



ITEM CODE	TRADE SIZE	INNER CASE	MASTER CASE
RGE50-45	1/2"	-	50
RGE75-45	3/4"	-	50
RGE100-45	1"	-	25
RGE125-45	1 1/4"	-	20
RGE150-45	1 1/2"	-	15
RGE200-45	2"	-	10
RGE250-45	2 1/2"	-	1
RGE300-45	3"	-	1
RGE350-45	3 1/2"	-	1
RGE400-45	4"	-	1

30°

ITEM CODE	TRADE SIZE	INNER CASE	MASTER CASE
RGE50-30	1/2"	-	50
RGE75-30	3/4"	-	50
RGE100-30	1"	-	25
RGE125-30	1 1/4"	-	20
RGE150-30	1 1/2"	-	15
RGE200-30	2"	-	10
RGE250-30	2 1/2"	-	1
RGE300-30	3"	-	1
RGE350-30	3 1/2"	-	1
RGE400-30	4"	-	1

"America's Electricity Runs On Flexotek"



THREADED ELBOWS GALVANIZED STEEL

22.5°



ITEM CODE	TRADE SIZE	INNER CASE	MASTER CASE
RGE50-22.5	1/2"	-	50
RGE75-22.5	3/4"	-	50
RGE100-22.5	1"	-	25
RGE125-22.5	1 1/4"	-	20
RGE150-22.5	1 1/2"	-	15
RGE200-22.5	2"	-	10
RGE250-22.5	2 1/2"	-	1
RGE300-22.5	3"	-	1
RGE350-22.5	3 1/2"	-	1
RGE400-22.5	4"	-	1

15°



ITEM CODE	TRADE SIZE	INNER CASE	MASTER CASE
RGE50-15	1/2"	-	50
RGE75-15	3/4"	-	50
RGE100-15	1"	-	25
RGE125-15	1 1/4"	-	20
RGE150-15	1 1/2"	-	15
RGE200-15	2"	-	10
RGE250-15	2 1/2"	-	1
RGE300-15	3"	-	1
RGE350-15	3 1/2"	-	1
RGE400-15	4"	-	1

**R
I
G
I
D
E
L
B
O
W
S**

"America's Electricity Runs On Flexotek"



PULL ELBOWS WITH COVER AND GASKET

COMBO TO COMBO

ITEM CODE	TRADE SIZE	INNER CASE	MASTER CASE
PEC50	1/2"	10	100
PEC75	3/4"	5	50
PEC100	1"	-	25



EMT TO EMT

ITEM CODE	TRADE SIZE	INNER CASE	MASTER CASE
PESS50	1/2"	10	100
PESS75	3/4"	5	50
PESS100	1"	-	25



RIGID TO RIGID

ITEM CODE	TRADE SIZE	INNER CASE	MASTER CASE
PET50	1/2"	10	100
PET75	3/4"	5	50
PET100	1"	-	25



P
U
L
L

E
L
B
O
W
S

"America's Electricity Runs On Flexotek"

PULL ELBOWS WITH COVER AND GASKET

COMBO TO BOX



ITEM CODE	TRADE SIZE	INNER CASE	MASTER CASE
PECBX-50	1/2"	10	100
PECBX-75	3/4"	5	50

EMT TO BOX



ITEM CODE	TRADE SIZE	INNER CASE	MASTER CASE
PESSBX-50	1/2"	10	100
PESSBX-75	3/4"	5	50

RIGID TO BOX



ITEM CODE	TRADE SIZE	INNER CASE	MASTER CASE
PET-BX50	1/2"	10	100
PETBX75	3/4"	5	50



P
U
L
L

E
L
B
O
W
S

EMT ELBOWS GALVANIZED STEEL

90°

ITEM CODE	TRADE SIZE	INNER CASE	MASTER CASE
EMT50-90	1/2"	-	50
EMT75-90	3/4"	-	50
EMT100-90	1"	-	25
EMT125-90	1 1/4"	-	20
EMT150-90	1 1/2"	-	15
EMT200-90	2"	-	10
EMT250-90	2 1/2"	-	1
EMT300-90	3"	-	1
EMT350-90	3 1/2"	-	1
EMT400-90	4"	-	1

45°

ITEM CODE	TRADE SIZE	INNER CASE	MASTER CASE
EMT50-45	1/2"	-	50
EMT75-45	3/4"	-	50
EMT100-45	1"	-	25
EMT125-45	1 1/4"	-	20
EMT150-45	1 1/2"	-	15
EMT200-45	2"	-	10
EMT250-45	2 1/2"	-	1
EMT300-45	3"	-	1
EMT350-45	3 1/2"	-	1
EMT400-45	4"	-	1

30°

ITEM CODE	TRADE SIZE	INNER CASE	MASTER CASE
EMT50-30	1/2"	-	50
EMT75-30	3/4"	-	50
EMT100-30	1"	-	25
EMT125-30	1 1/4"	-	20
EMT150-30	1 1/2"	-	15
EMT200-30	2"	-	10
EMT250-30	2 1/2"	-	1
EMT300-30	3"	-	1
EMT350-30	3 1/2"	-	1
EMT400-30	4"	-	1



E
M
T

E
L
B
O
W
S



"America's Electricity Runs On Flexotek"

EMT ELBOWS GALVANIZED STEEL



**E
M
T

E
L
B
O
W
S**

22.5°



ITEM CODE	TRADE SIZE	INNER CASE	MASTER CASE
EMT50-22.5	1/2"	-	50
EMT75-22.5	3/4"	-	50
EMT100-22.5	1"	-	25
EMT125-22.5	1 1/4"	-	20
EMT150-22.5	1 1/2"	-	15
EMT200-22.5	2"	-	10
EMT250-22.5	2 1/2"	-	1
EMT300-22.5	3"	-	1
EMT350-22.5	3 1/2"	-	1
EMT400-22.5	4"	-	1

15°



ITEM CODE	TRADE SIZE	INNER CASE	MASTER CASE
EMT50-15	1/2"	-	50
EMT75-15	3/4"	-	50
EMT100-15	1"	-	25
EMT125-15	1 1/4"	-	20
EMT150-15	1 1/2"	-	15
EMT200-15	2"	-	10
EMT250-15	2 1/2"	-	1
EMT300-15	3"	-	1
EMT350-15	3 1/2"	-	1
EMT400-15	4"	-	1

"America's Electricity Runs On Flexotek"



E
L
E
C
T
R
I
C
A
L
T
A
P
E

PVC ELECTRICAL TAPE

- * Max Operating Temperature 176 F (80 C)
- * PVC with sensitive layer of Adhesive
- * Dielectric Strength: 44 Kv/mm
- * Tensile Strength: 28.7 N/cm
- * Adhesion to Steel :1.75 N/cm
- * Elongation at Brake: 301%
- * 7 Mil ,3/4" x 60' (.182mm x 19mm x 18.29m)
- * Flame Retardant

ITEM CODE	INNER SLEEVE	MASTER CASE
BLACK TAPE	10	200
WHITE TAPE	10	200
RED TAPE	10	200
BLUE TAPE	10	200
GREEN TAPE	10	200
YELLOW TAPE	10	200
ORANGE TAPE	10	200
BROWN TAPE	10	200
GRAY TAPE	10	200



"America's Electricity Runs On Flexotek"

THREADED INSULATED MALLEABLE IRON GROUNDING BUSHINGS WITH ALUMINUM LUG



S
G
N
-
I
S
C
B
G
N
-
D
N
C
O
R
G

ITEM CODE	TRADE SIZE	WIRE SIZE MIN / MAX	INNER CASE	MASTER CASE
MIGB50	1/2"	14 / 4	50	500
MIGB75	3/4"	14 / 4	25	250
MIGB100	1"	14 / 4	20	200
MIGB125	1 1/4"	14 / 4	10	100
MIGB150	1 1/2"	14 / 4	10	100
MIGB200	2 "	14 / 4	10	100
MIGB250	2 1/2"	14 1/0	-	25
MIGB300	3 "	14 1/0	-	25
MIGB350	3 1/2"	14 1/0	-	10
MIGB400	4"	14 1/0	-	10



"America's Electricity Runs On Flexotek"



5361 Preston Ct • Brooklyn, NY 11234 • Tel. 718-257-9300 • Fax. 718-257-9303 • 1 866-4FLEXOTEK • www.flexotek.com

**THREADED INSULATED DIE CAST
GROUNDING BUSHINGS WITH ALUMINUM LUG**



ITEM CODE	TRADE SIZE	WIRE SIZE MIN / MAX	INNER CASE	MASTER CASE
DCGB50	1/2"	14 / 4	50	500
DCGB75	3/4"	14 / 4	25	250
DCGB100	1"	14 / 4	20	200
DCGB125	1 1/4"	14 / 4	10	100
DCGB150	1 1/2"	14 / 4	10	100
DCGB200	2 "	14 / 4	10	100
DCGB250	2 1/2"	14 1/0	-	25
DCGB300	3 "	14 1/0	-	25
DCGB350	3 1/2"	14 1/0	-	10
DCGB400	4"	14 1/0	-	10



GROUNDING BUSHINGS

"America's Electricity Runs On Flexotek"

RIGID FITTINGS STEEL



RIGID (THREADLESS) COMPRESSION CONNECTORS



ITEM CODE	TRADE SIZE	INNER CASE	MASTER CASE
RC-CON50	1/2"	20	200
RC-CON75	3/4"	10	100
RC-CON100	1"	5	50
RC-CON125	1 1/4"	5	50
RC-CON150	1 1/2"	12	48
RC-CON200	2"	12	48
RC-CON250*	2 1/2"	-	1
RC-CON300*	3"	-	1
RC-CON350*	3 1/2"	-	1
RC-CON400*	4"	-	1

RIGID (THREADLESS) COMPRESSION COUPLINGS



ITEM CODE	TRADE SIZE	INNER CASE	MASTER CASE
RC-COUP50	1/2"	20	200
RC-COUP75	3/4"	10	100
RC-COUP100	1"	5	50
RC-COUP125	1 1/4"	5	50
RC-COUP150	1 1/2"	12	48
RC-COUP200	2"	12	48
RC-COUP250*	2 1/2"	-	1
RC-COUP300*	3"	-	1
RC-COUP350*	3 1/2"	-	1
RC-COUP400*	4"	-	1

*MALLEABLE IRON

R
I
G
I
D
F
I
T
T
I
N
G
S



3 PIECE COUPLING - MALLEABLE IRON



ITEM CODE	TRADE SIZE	INNER CASE	MASTER CASE
3PC50-MI	1/2"	20	200
3PC75-MI	3/4"	10	100
3PC100-MI	1"	5	50
3PC125-MI	1 1/4"	5	50
3PC150-MI	1 1/2"	3	30
3PC200-MI	2"	2	20
3PC250-MI	2 1/2"	2	10
3PC300-MI	3 "	-	1
3PC350-MI	3 1/2"	-	1
3PC400-MI	4"	-	1

**RIGID-FIT
SIZES**

"America's Electricity Runs On Flexotek"

REDUCING BUSHINGS STEEL



ITEM CODE	TRADE SIZE	INNER CASE	MASTER CASE
RBS75-50	3/4" x 1/2"	--	50
RBS100-50	1" x 1/2"	--	50
RBS100-75	1" x 3/4"	--	50
RBS125-50	1 1/4" x 1/2"	--	25
RBS125-75	1 1/4" x 3/4"	--	25
RBS125-100	1 1/4" x 1"	--	25
RBS150-50	1 1/2" x 1/2"	--	25
RBS150-75	1 1/2" x 3/4"	--	25
RBS150-100	1 1/2" x 1"	--	25
RBS150-125	1 1/2" x 1 1/4"	--	25
RBS200-50	2" x 1/2"	--	10
RBS200-75	2" x 3/4"	--	10
RBS200-100	2" x 1"	--	10
RBS200-125	2" x 1 1/4"	--	10
RBS200-150	2" x 1 1/2"	--	10

REDUCING BUSHINGS

REDUCING BUSHINGS STEEL



ITEM CODE	TRADE SIZE	INNER CASE	MASTER CASE
RBS250-125	2 1/2" x 1 1/4"	--	10
RBS250-150	2 1/2" x 1 1/2"	--	10
RBS250-200	2 1/2" x 2"	--	10
RBS300-125	3" x 1 1/4"	--	10
RBS300-150	3" x 1 1/2"	--	10
RBS300-200	3" x 2"	--	10
RBS300-250	3" x 2 1/2"	--	10
RBS350-200	3 1/2" X 2"	---	10
RBS350-250	3 1/2" x 2 1/2"	--	10
RBS350-300	3 1/2" x 3"	--	10
RBS400-200	4" x 2"	--	10
RBS400-250	4 "x 2 1/2"	--	10
RBS400-300	4" x 3"	--	10

REDUCING BUSHINGS

"America's Electricity Runs On Flexotek"



5361 Preston Ct • Brooklyn, NY 11234 • Tel. 718-257-9300 • Fax. 718-257-9303 • 1 866-4FLEXOTEK • www.flexotek.com

REDUCING WASHERS STEEL



ITEM CODE	TRADE SIZE	INNER CASE	MASTER CASE
RW 75-50	3/4" x 1/2"	--	50
RW100-50	1" x 1/2"	--	50
RW100-75	1" x 3/4"	--	50
RW125-50	1 1/4" x 1/2"	--	25
RW125-75	1 1/4" x 3/4"	--	25
RW125-100	1 1/4"x 1"	--	25
RW150-50	1 1/2" x 1/2"	--	25
RW150-75	1 1/2" x 3/4"	--	25
RW150-100	1 1/2" x 1"	--	25
RW150-125	1 1/2" x 1 1/4"	--	25
RW200-50	2" x 1/2"	--	10
RW200-75	2" x 3/4"	--	10
RW200-100	2" x 1"	--	10
RW200-125	2" x 1 1/4"	--	10
RW200-150	2" x 1 1/2"	--	10

"America's Electricity Runs On Flexotek"



5361 Preston Ct • Brooklyn, NY 11234 • Tel. 718-257-9300 • Fax. 718-257-9303 • 1 866-4FLEXOTEK • www.flexotek.com

REDUCING WASHERS STEEL



ITEM CODE	TRADE SIZE	INNER CASE	MASTER CASE
RW250-50	2 1/2" x 1/2"	--	10
RW250-75	2 1/2" x 3/4"	--	10
RW250-100	2 1/2" x 1"	--	10
RW250-125	2 1/2" x 1 1/4"	--	10
RW250-150	2 1/2" x 1 1/2"	--	10
RW300-50	3" x 1/2"	-	10
RWS300-75	3" x 3/4"	--	10
RW300-100	3" x 1"	---	10
RW300-125	3" x 1 1/4"	--	10
RW300-150	3" x 1 1/2"	--	10
RW300-200	3" x 2"	--	10
RW300-250	3" x 2 1/2"	--	10
RW350-50	3 1/2" x 1/2"	-	10
RW350-75	3 1/2" x 3/4"	--	10
RW350-100	3 1/2" x 1"	---	10
RW350-125	3 1/2" x 1 1/4"	--	10
RW350-150	3 1/2" x 2"	--	10
RW350-200	3 1/2" x 2"	-	10
RW350-250	3 1/2" x 2 1/2"	-	10
RBS350-300	3 1/2" x 3"	-	10

"America's Electricity Runs On Flexotek"



5361 Preston Ct • Brooklyn, NY 11234 • Tel. 718-257-9300 • Fax. 718-257-9303 • 1 866-4FLEXOTEK • www.flexotek.com

REDUCING WASHERS STEEL



ITEM CODE	TRADE SIZE	INNER CASE	MASTER CASE
RW400-50	4" x 1/2"	--	10
RBS400-75	4" x 3/4"	--	10
RBS400-100	4" x 1"	--	10
RBS400-125	4" x 1 1/4"	-	10
RBS400-150	4" x 1 1/2"	--	10
RBS400-200	4 x 2"	--	10
RBS400-250	4" x 2 1/2"	-	10
RBS400-300	4" x 3"	--	10
RBS400-350	4" x 3 1/2"	-	10

"America's Electricity Runs On Flexotek"

NYLON PRODUCTS

EMT CONDUIT INSULATING BUSHINGS



ITEM CODE	TRADE SIZE	INNER CASE	MASTER CASE
E BUSHINGS 50	1/2"	100	1000
E BUSHINGS 75	3/4"	50	1000
E BUSHINGS 100	1"	25	500
E BUSHINGS 125	1 1/4"	25	250
E BUSHINGS 150	1 1/2"	25	250
E BUSHINGS 200	2"	20	200
E BUSHINGS 250	2 1/2"	--	25
E BUSHINGS 300	3"	--	25
E BUSHINGS 350	3 1/2"	--	25
E BUSHINGS 400	4"	--	25



NYLON PRODUCTS

"America's Electricity Runs On Flexotek"

EMT RAIN TIGHT FITTINGS STEEL INSULATED



EMT RAIN TIGHT COMPRESSION CONNECTORS STEEL INSULATED



ITEM CODE	TRADE SIZE	INNER CASE	MASTER CASE
RT-CON50	1/2"	25	250
RT-CON75	3/4"	25	250
RT-CON100	1"	10	100
RT-CON125	1 1/4"	-	25
RT-CON150	1 1/2"	-	20
RT-CON200	2"	-	15
RT-CON250	2 1/2"	-	12
RT-CON300	3"	-	12
RT-CON350	3 1/2"	-	6
RT-CON400	4"	-	6

EMT RAIN TIGHT COMPRESSION COUPLINGS STEEL





ITEM CODE	TRADE SIZE	INNER CASE	MASTER CASE
RT-COUP50	1/2"	25	250
RT-COUP75	3/4"	25	250
RT-COUP100	1"	10	100
RT-COUP125	1 1/4"	-	25
RT-COUP150	1 1/2"	-	20
RT-COUP200	2"	-	15
RT-COUP250	2 1/2"	-	12
RT-COUP300	3"	-	12
RT-COUP350	3 1/2"	-	6
RT-COUP400	4"	-	6

RAIN TIGHT FITTINGS

"America's Electricity Runs On Flexotek"

YELLOW TWISTED POLYPROPYLENE ROPE

	ITEM CODE	TRADE SIZE	INNER CASE	MASTER CASE
	YROPE-38300	3/8" X 300FT		1
	YROPE-38600	3/8" X 600FT		1
	YROPE-381200	3/8" X 1200FT		1
	YROPE-25300	1/4" X 300FT		1
	YROPE-25600	1/4" X 600FT		1
	YROPE-50300	1/2" X 300FT		1
	YROPE-50600	1/2" X 600 FT		1
	YROPE-75300	3/4" X 300 FT		1
	YROPE- 75600	3/4" X 600FT		1

PREMIUM GRADE, U.V., STABILIZED POLYPROPYLENE FIBER, ECONOMICAL, LIGHTWEIGHT, FLOATS, ROT PROOF, RESISTS OIL, WATER, GASOLINE AND MOST CHEMICALS.

Y
E
L
L
O
W

R
O
P
E

CABLE SUPPORT



FLEX-J6



CABLE SUPPORT FOR MC OR NON METALLIC CABLE
WOOD OR METAL STUD APPLICABLE

ITEM CODE	TRADE SIZE	INNER CASE	MASTER CASE
FLEX-J6	N/A	100	1000

TELESCOPING BRACKET



PILOT HOLES FOR EASY ATTACHMENT
ADJUSTABLE FOR NON STANDARD STUD SPACING
TELESCOPING BRACKET EXPANDABLE.
EASY INSTALLATION, REQUIRES ONLY SCREW GUN

ITEM CODE	TRADE SIZE	INNER CASE	MASTER CASE
TSBK16	11"-18"	N/A	50
TSBK24	17"-26"	N/A	50



RIGID BOX SUPPORT

FLEX-RBS16

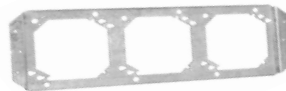

FLEX-RBS24

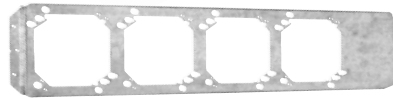

FOR USE WITH 4" AND 4 11/16 " BOXES
 1 BRACKET SUPPORTS MULTIPLE BOXES OR DEVICES
 16" AND 24" AVAILABLE FOR YOUR CONVENIENCE.

ITEM CODE	DEVICE QTY .	INNER CASE	MASTER CASE
FLEX-RBS16	3	N/A	25
FLEX-RBS24	4	N/A	25

BRACKET TO STUD SUPPORT

FLEX-C23

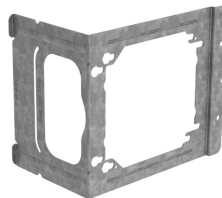

ITEM CODE	STUD WALL DEPTH	MASTER CASE
FLEX C23	2 1/2" & 3 5/8"	50

"America's Electricity Runs On Flexotek"



5361 Preston Ct • Brooklyn, NY 11234 • Tel. 718-257-9300 • Fax. 718-257-9303 • 1 866-4FLEXOTEK • www.flexotek.com

POLYPROPYLENE CONDUIT BLOW LINE

ITEM CODE	TRADE SIZE	INNER CASE	MASTER CASE
CBL6500	6500FT	-	1



**Size
#650**

**Color
White/Blue**

**Weight lbs.
8.00**

**Breaking Strength lbs.
210lbs.**

Technical Information:

Material: Polypropylene Monofilament

Specific Gravity: 0.91 (Floats)

Stretch Elongation at Breaking Point: 18 to 22%

Elastic Recovery: 98% at 5%, 95% at 10%

Moisture Absorbency: Negligible

Effect of Heat: 50% Tensile at 200° F. Melts at 320°

Effect Of Acids: Good resistance except with oxidizing agents.

Effect of Alkalis: Good resistance

Effect of Organic Solvents: Insoluble in most except chlorinated hydrocarbons.

Effect of Sunlight: Good resistance to indirect sunlight

Effect of Age: Negligible

Resistance to Mildew: Not attacked

Abrasion Resistance: Good resistance

Identification: Floats. Melts before burning. Forms hard bead. Burning asphalt odor.

Key Features:

- Smaller format bucket takes up less room in your truck
- Good knotting capabilities

"America's Electricity Runs On Flexotek"

Round Pancake Boxes



Features

- Pancake box-fixture ready, galvanized steel raised 1/2" and 3/4"

Applications

- Flexotek pancake ceiling box can be used to install ceiling fans, lighting fixtures and other electrical devices

Standard Material

- Galvanized steel

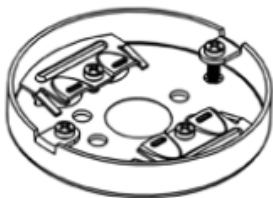

FLEX287

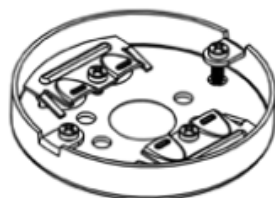

FLEX292

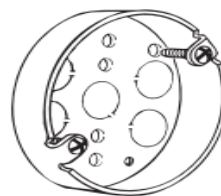

FLEX293

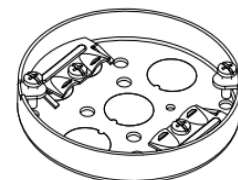

FLEX56111-R

Catalog Number	Description	Depth	Cubic Inches	Ship Case	Weight/Case
FLEX292	3-1/2" round steel pancake box with NM Clamp	1/2"	4.0	50	13.4
FLEX287	3-1/2" round steel pancake box with NM clamp	3/4"	5.0	50	15.4
FLEX293	4" round steel pancake box with 1/2"KO	1/2"	6.0	50	17.8
FLEX56111-R	4" round steel pancake box with NM Clamp	1/2"	6.0	50	19.6

3-1/2" Octagon Drawn Box 1-1/2" Deep



Features

- Drawn
- 1-1/2" deep
- 11.8 cubic inches
- Available in multiple KO sizes, with or without concentric KOs and raised ground emboss with installed 10/32 ground screw where noted

Applications

- 3-1/2" octagon junction boxes are used to install ceiling and wall lighting fixtures, fans or convenience outlets and devices
- Octagon boxes are used to bring power to an electrical device where multiple conductor runs are split in two or more directions

Standard Material

- Galvanized steel

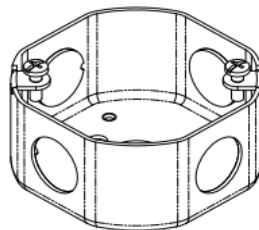

FLEX110

Catalog Number	Description	Knockouts		Cubic Inches	Ship Case	Weight/Case
		Sides	Bottom			
FLEX110	1-1/2" deep 1/2" KO	(4) - 1/2"	(1) - 1/2"	11.8	50	19.6

4" Octagon Drawn Boxes & Extensions

1-1/2" Deep



Features

- Drawn
- 1-1/2" deep
- 15.5 cubic inches
- Available in multiple KO sizes, with or without concentric KOs and raised ground emboss with installed 10/32 ground screw where noted

Applications

- 4" octagon junction boxes are used to install ceiling and wall lighting fixtures, fans or convenience outlets and devices
- Octagon boxes are used to bring power to an electrical device where multiple conductor runs are split in two or more directions

Standard Material

- Galvanized steel

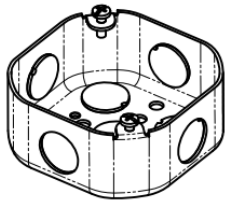

FLEX125

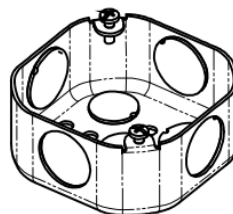

FLEX126

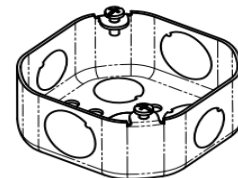

FLEX127

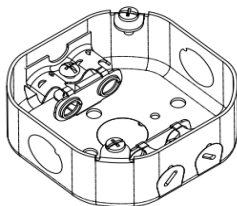

FLEX153

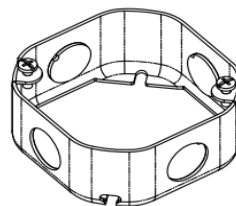

FLEX128

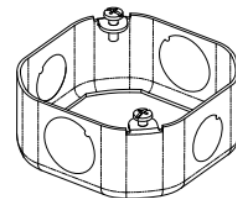

FLEX130

Catalog Number	Description	Knockouts		Cubic Inches	Ship Case	Weight/Case
		Sides	Bottom			
BOXES						
FLEX125	1-1/2" deep 1/2" KO with raised ground emboss	(4) - 1/2"	(4) - 1/2"	15.5	50	26
FLEX126	1-1/2" deep 3/4" KO with raised ground emboss	(4) - 3/4"	(2) - 1/2" & (2) - 3/4"	15.5	50	26
FLEX127	1-1/2" deep 1/2" & 3/4" KO with raised ground emboss	(2) - 1/2" & (2) - 3/4"	(2) - 1/2" & (2) - 3/4"	15.5	50	26
FLEX153	1-1/2" deep 1/2" KO with MC Clamp	(2) - 1/2" & 4 pryouts	(1) - 1/2"	15.5	50	26
EXTENSIONS						
FLEX128	1-1/2" deep 1/2" KO	(4) - 1/2"	---	15.5	50	19
FLEX130	1-1/2" deep 1/2" & 3/4" KO	(2) - 1/2" & (2) - 3/4"	---	15.5	50	19

4" Octagon Drawn Boxes with Brackets and Supports 1-1/2" Deep

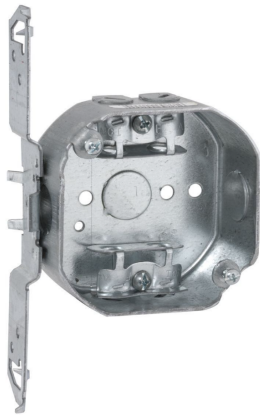

Features

- Drawn
- 1-1/2" deep
- 15.5 cubic inches
- Available with multiple KO sizes, and various clamps and brackets
- Adjustable bar hanger lengths 14-1/4" to 22-1/2"

Application

- 4" octagon junction boxes are used to install ceiling and wall lighting fixtures, or convenience outlets and devices
- Octagon boxes are used to bring power to an electrical device where multiple conductor runs are split in two or more directions

Standard Material

- Galvanized steel

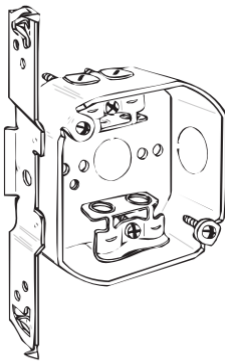

FLEX155

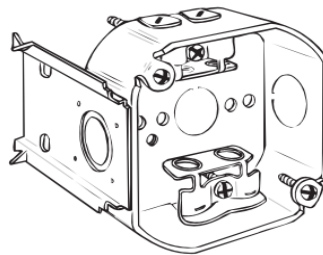

FLEX157

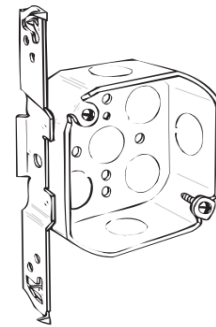

FLEX161

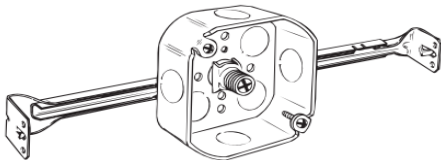

FEX324*

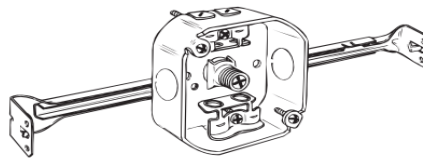

FLEX325*

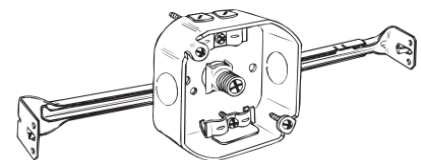

FLEX326*

Catalog Number	Description	Knockouts		Cubic Inches	Ship Case	Weight/Case
		Sides	Bottom			
FLEX155	1-1/2" deep 1/2" KO with MC clamp & TS bracket	(1) - 1/2" & 4 pryouts	(1) 1/2"	15.5	50	35
FLEX157	1-1/2" deep 1/2" KO with MC clamp & J-Wood bracket	(2) - 1/2" & 4 pryouts	(1) 1/2"	15.5	50	32
FLEX161	1-1/2" deep 1/2" KO with TS bracket	(2) - 1/2" & (1) - 3/4"	(3) - 1/2" & (2) - 3/4"	15.5	50	31
FLEX324*	1-1/2" deep 1/2" KO with adj. bar hanger	(4) 1/2"	(4) 1/2"	15.5	25	23
FLEX325*	1-1/2" deep 1/2" KO with MC clamp & adj. bar hanger	(2) - 1/2" & 4 pryouts	-----	15.5	25	24
FLEX326*	1-1/2" deep 1/2" KO with NM clamp & adj. bar hanger	(2) -1/2" & 4 pryouts	-----	15.5	25	23.5

*Maximum weight load of 55 Lbs. when bar hanger extended 14" and maximum weight load of 33 Lbs. when bar hanger extended 21"

4" Octagon Drawn Deep Boxes & Covers

2-1/8" Deep



Features

- Boxes – Drawn
- Boxes – 2-1/8" deep
- Boxes – 21.5 cubic inch extra cubic capacity
- Available in multiple KO sizes, with or without concentric KOs and raised ground emboss with installed 10/32 ground screw where noted

Applications

- 4" octagon junction boxes are used to install ceiling and wall lighting fixtures, fans or convenience outlets and devices
- Octagon boxes are used to bring power to an electrical device where multiple conductor runs are split in two or more directions
- 4" octagon blank flat covers are used to cover 4" octagon box wiring and provide a means for access when future conduit runs are required

Standard Material

- Galvanized steel

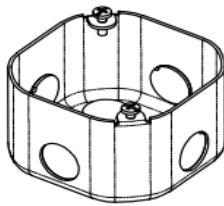

FLEX165

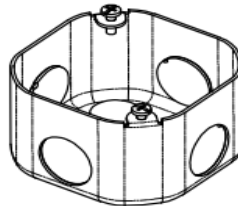

FLEX166

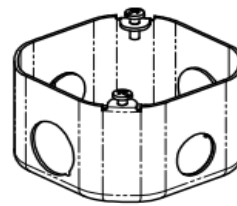

FLEX167

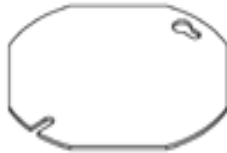

FLEX722

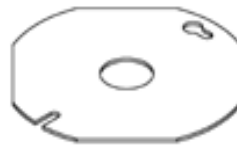

FLEX724

Catalog Number	Description	Knockouts		Cubic Inches	Ship Case	Weight/Case
		Sides	Bottom			
BOXES						
FLEX165	2-1/8" deep 1/2" KO with raised ground emboss	(4) - 1/2"	(4) - 1/2"	21.5	50	29
FLEX166	2-1/8" deep 1/2" & 3/4" KO with raised ground emboss	(4) - 3/4"	(2) - 1/2" & (2) - 3/4"	21.5	50	29
FLEX167	2-1/8" deep 1/2" & 3/4" KO with raised ground emboss	(2) - 1/2" & (2) - 3/4"	(2) - 1/2" & (2) - 3/4"	21.5	50	29
COVERS						
FLEX722	Blank flat (1) Hole & (1) Slot	---	---	---	100	23
FLEX724	Flat (1) 1/2" KO, (1) Hole & (1) Slot	---	(1) - 1/2"	---	100	23

4" Square Extensions



Features

- 1-1/2" deep
- 21 cubic inches
- Add to junction boxes for additional wiring capacity

Applications

- Increases wiring capacity
- Provides access for additional conduit runs and electrical wire

Standard Material

- Galvanized steel

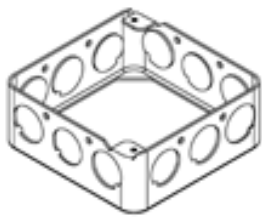

FLEX201

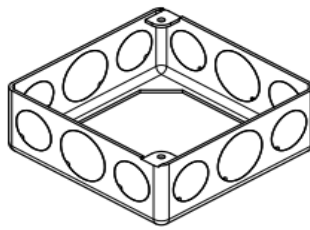

FLEX203

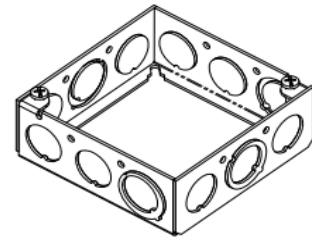

FLEX53151-MKO

Catalog Number	Description	Knockouts Sides	Cubic Inches	Ship Case	Weight/Case
FLEX201	Extension 1-1/2" deep 1/2" KO - Drawn	(12) - 1/2"	21	50	20
FLEX203	Extension 1-1/2" deep 1/2" & 3/4" KO - Drawn	(8) - 1/2" & (4) - 3/4"	21	50	20
FLEX53151-MKO	Extension 1-1/2" deep 1/2" & 3/4" eccentric - Welded	(8) - 1/2" & (4) - 1/2"&3/4" Ecc	21	50	20

4" Square Drawn Boxes 1-1/2" Deep



Features

- Drawn
- 1-1/2" deep
- Available in multiple KO sizes with raised ground emboss with installed 10/32 ground screw and pigtail where noted

Applications

- 4" square drawn junction boxes can be installed in walls or ceilings for lighting fixtures, switches, receptacles or other outlet devices.
- Square boxes are used to bring power to a number of electrical devices where multiple conductor runs are split in two or more directions

Standard Material

- Galvanized steel

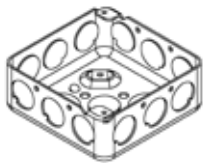

FLEX190

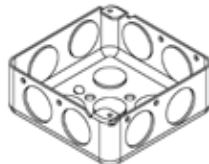

FLEX191

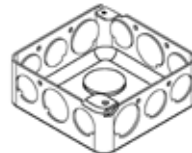

FLEX192



FLEX52151-CKO

Catalog Number	Description	Sides	Knockouts Bottom	Cubic Inches	Ship Case	Weight/Case
FLEX190	1-1/2" deep 1/2" KO with raised ground emboss	(12) - 1/2"	(4) - 1/2"	21	50	31
FLEX191	1-1/2" deep 3/4" KO with raised ground emboss	(8) - 3/4"	(2) - 1/2" & (2) - 3/4"	21	50	31
FLEX192	1-1/2" deep 1/2" & 3/4" KO with raised ground emboss	(8) - 1/2" & (4) - 3/4"	(2) - 1/2" & (2) - 3/4"	21	50	31
FLEX52151-CKO	1-1/2" deep 1/2" & 3/4" concentric KO with raised ground emboss	(8) - 1/2" & 3/4" Con	(2) - 1/2" & (2) - 3/4"	21	50	31

4" Square Welded Boxes 1-1/2" Deep

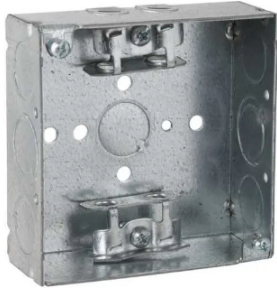

Features

- Welded
- 1-1/2" deep
- Available in multiple KO sizes, and eccentric KOs and pigtail where noted

Applications

- 4" square welded junction boxes can be installed in walls or ceilings for lighting fixtures, switches, receptacles or other outlet devices
- Square boxes are used to bring power to a number of electrical devices where multiple conductor runs are split in two or more directions

Standard Material

- Galvanized steel

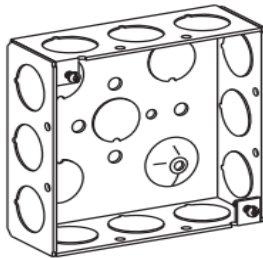

FLEX52151-1/2

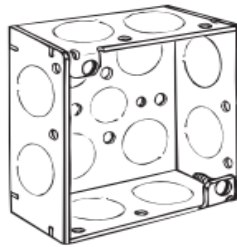

FLEX52151-3/4

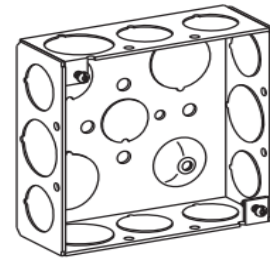

FLEX52151-1234

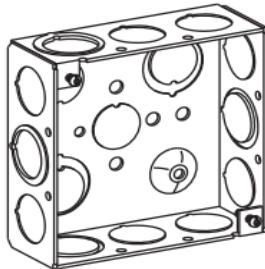

FLEX189

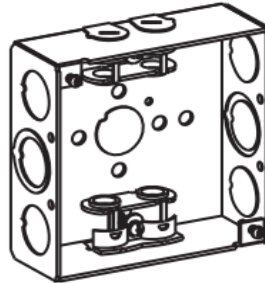

FLEX213

Catalog Number	Description	Sides	Knockouts Bottom	Cubic Inches	Ship Case	Weight/Case
FLEX52151-1/2	1-1/2" deep 1/2" KO with raised ground emboss	(12) - 1/2"	(2) - 1/2" (2) - 3/4"	21	50	31
FLEX52151-3/4	1-1/2" deep 3/4" KO with raised ground emboss	(8) - 3/4"	(2) - 1/2" (2) - 3/4"	21	50	31
FLEX52151-1234	1-1/2" deep 1/2" & 3/4" KO with raised ground emboss	(8) - 1/2" (4) - 3/4"	(2) - 1/2" (2) - 3/4"	21	50	31
FLEX189	1-1/2" deep 1/2" & 3/4" eccentric KO with raised ground emboss	(8) - 1/2" & (4) - 1/2" & 3/4" Ecc	(2) - 1/2" (2) - 1/2" & 3/4" Ecc	21	50	36
FLEX213	1-1/2" deep 1/2" KO with MC Clamp	(4) - 1/2" & (2) - 1/2" & 3/4" Ecc	(1) - 1/2"	21	50	39

4" Square Welded Boxes

1-1/2" Deep with Bracket



Features

- Welded
- 1-1/2" deep
- Available in multiple KO sizes, with brackets, NM clamps, MC clamps, eccentric KOs and pigtail where noted

Applications

- 4" square welded junction boxes can be installed in walls or ceilings for lighting fixtures, switches, receptacles or other outlet devices
- Square boxes are used to bring power to a number of electrical devices where multiple conductor runs are split in two or more directions

Standard Material

- Galvanized steel

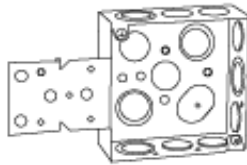

FLEX193

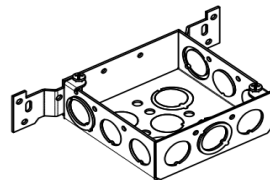

FLEX196

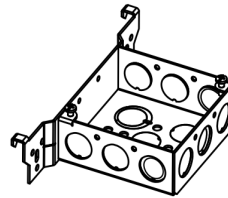

FLEX197

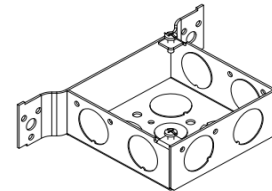

FLEX199

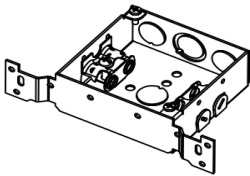

FLEX218

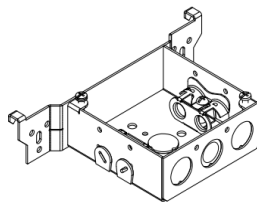

FLEX219

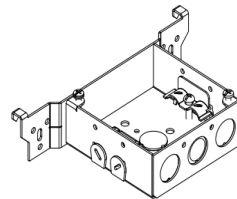

FLEX220

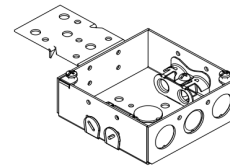

FLEX224

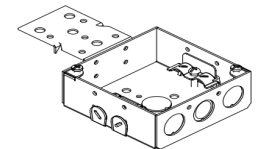

FLEX225

Catalog Number	Description	Sides	Knockouts		Cubic Inches	Ship Case	Weight/ Case
			Bottom				
FLEX193	1-1/2" deep 1/2" & 3/4" eccentric KO with S bracket & raised ground emboss	(6) - 1/2" & (3) - 1/2" & 3/4" Ecc	(2) - 1/2" & (2) - 1/2" & 3/4"Ecc	21	25	20	
FLEX196	1-1/2" deep 1/2" & 3/4" eccentric KO with FL bracket	(6) - 1/2" & (3) - 1/2" & 3/4" Ecc	(3) - 1/2" & (2) - 1/2" & 3/4"Ecc	21	25	22	
FLEX197	1-1/2" deep 1/2" KO with WB bracket	(6) - 1/2" & (3) - 1/2" & 3/4" Ecc	(3) - 1/2" & (2) - 1/2" & 3/4"Ecc	21	25	21	
FLEX199	1-1/2" deep 1/2" & 3/4" KO with FL bracket	(6) - 3/4"	(2) - 1/2" & (2) - 3/4"	21	25	22	
FLEX220	1-1/2" deep 1/2" & 3/4" eccentric KO with NM Clamp & FL bracket	(2) - 1/2" & (1) - 1/2" & 3/4" Ecc	(1) - 1/2"	21	25	24	
FLEX218	1-1/2" deep 1/2" & 3/4" eccentric KO with MC Clamp & FL bracket	(2) - 1/2" & (1) - 1/2" & 3/4" Ecc & 4 pryouts	(1) - 1/2"	21	25	22	
FLEX219	1-1/2" deep 1/2" & 3/4" eccentric KO with MC Clamp & FH bracket	(2) - 1/2" & (1) - 1/2" & 3/4" Ecc & 4 pryouts	(1) - 1/2"	21	25	20	
FLEX224	1-1/2" deep 1/2" & 3/4" eccentric KO with MC Clamp & S bracket	(2) - 1/2" & (1) - 1/2" & 3/4" Ecc & 4 pryouts	(1) - 1/2"	21	25	24	
FLEX225	1-1/2" deep 1/2" KO with NM Clamp & S bracket	(4) - 1/2" & 4 pryouts	(1) - 1/2"	21	25	22	

4" Square Welded Deep Boxes

2-1/8" Deep



Features

- Welded
- 2-1/8" deep offer extra cubic capacity
- Available in multiple eccentric & concentric KO sizes with MC clamps, raised ground emboss with 10/32 ground screw and pigtail where noted

Applications

- 4" square welded junction boxes can be installed in walls or ceilings for lighting fixtures, switches, receptacles or other outlet devices
- Square boxes are used to bring power to a number of electrical devices where multiple conductor runs are split in two or more directions

Standard Material

- Galvanized steel

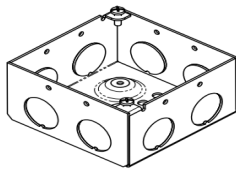

FLEX231

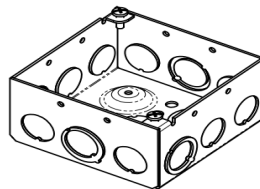

FLEX232

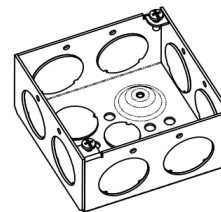

FLEX233

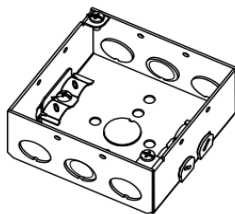

FLEX242

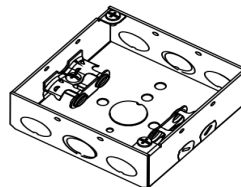

FLEX248

Catalog Number	Description	Sides	Knockouts Bottom	Cubic Inches	Ship Case	Weight/Case
FLEX231	2-1/8" deep 1/2" & 3/4" eccentric KO with raised ground emboss	(8) - 1/2"	(2) - 1/2" & 3/4" Ecc & (2) - 1/2"	30.0	25	22
FLEX232	2-1/8" deep 1/2" & 3/4" eccentric KO with raised ground emboss	(8) - 1/2" & (4) 1/2" & 3/4" Ecc	(2) - 1/2" & 3/4" Ecc & (2) - 1/2"	30.0	25	22
FLEX233	2-1/8" deep 1/2" & 3/4" KO with raised ground emboss	(8) - 1"	(2) - 1/2" & (2)-3/4"	30.0	25	22
FLEX242	2-1/8" deep 1/2" & 3/4" eccentric KO with NM clamp	(4) - 1/2" & (2) 1/2" & 3/4" Ecc & 4 pryouts	(1) - 1/2"	30.0	25	22
FLEX248	2-1/8" deep 1/2" & 3/4" eccentric KO with MC clamp	(4) - 1/2" & (2) 1/2" & 3/4" Ecc & 4 pryouts	(1) - 1/2"	30.0	25	23

4" Square Welded Deep Boxes 2-1/8" Deep with Bracket



Features

- Welded
- 2-1/8" deep offer extra cubic capacity
- Available in multiple eccentric KO sizes with MC clamps, NM clamp, brackets, 10/32 ground screw and pigtail where noted

Applications

- 4" square welded junction boxes can be installed in walls or ceilings for lighting fixtures, switches, receptacles or other outlet devices
- Square boxes are used to bring power to a number of electrical devices where multiple conductor runs are split in two or more directions

Standard Material

- Galvanized steel

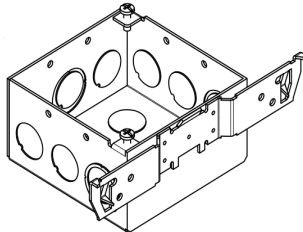

FLEX235

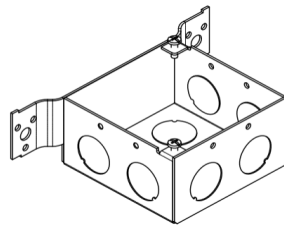

FLEX236

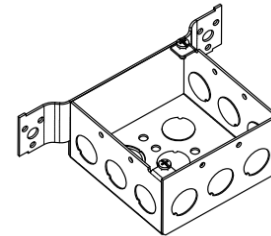

FLEX237

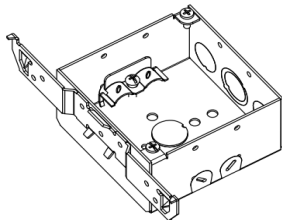

FLEX240

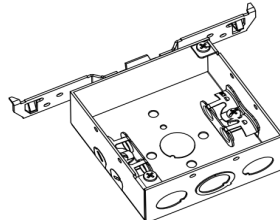

FLEX241

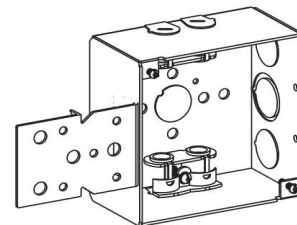

FLEX249

Catalog Number	Description	Knockouts		Cubic Inches	Ship Case	Weight/Case
		Sides	Bottom			
FLEX235	2-1/8" deep 1/2" & 3/4" eccentric KO with TS bracket	(6) - 1/2" & (3) - 1/2" & 3/4" Ecc	(2) - 1/2" & (2) - 1/2" & 3/4" Ecc	30.3	25	25
FLEX236	2-1/8" deep 1/2" & 3/4" KO with FL bracket	(6) - 3/4"	(1) - 1/2" & (4) - 3/4"	30.3	25	24
FLEX237	2-1/8" deep 1/2" & 3/4" KO with FL bracket	(9) - 1/2"	(3) - 1/2" & (2) - 1/2" & 3/4" Ecc	30.3	25	24
FLEX240	2-1/8" deep 1/2" & 3/4" eccentric KO with NM Clamp & TS bracket	(2) - 1/2" & (1) - 1/2" & 3/4" Ecc & 4 pryouts	(1) - 1/2"	30.3	25	28
FLEX241	2-1/8" deep 1/2" & 3/4" eccentric KO with MC Clamp & TS bracket	(2) - 1/2" & (1) - 1/2" & 3/4" Ecc & 4 pryouts	(1) - 1/2"	30.3	25	29
FLEX249	2-1/8" deep 1/2" & 3/4" eccentric KO with MC Clamp & B bracket	(2) - 1/2" & (1) - 1/2" & 3/4" Ecc & 4 pryouts	(1) - 1/2"	30.3	25	29

4" Square Welded Boxes 2-1/8" Deep with Metal Stud Bracket

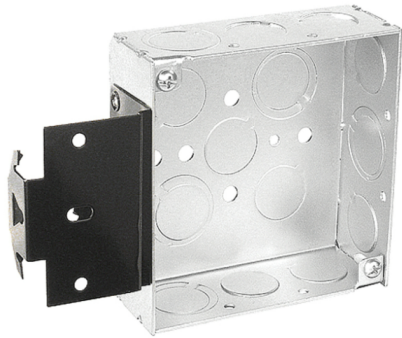

Features

- Welded
- Metal stud bracket
- 2-1/8" deep boxes offer extra cubic capacity
- Available with MCI clamp

Applications

- Built in metal stud bracket allows 4" square box to mount directly to a metal stud
- Square boxes are used to bring power to a number of electrical devices where multiple conductor runs are split in two or more directions

Standard Material

- Galvanized steel

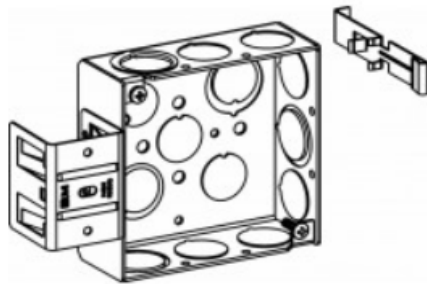

FLEX238

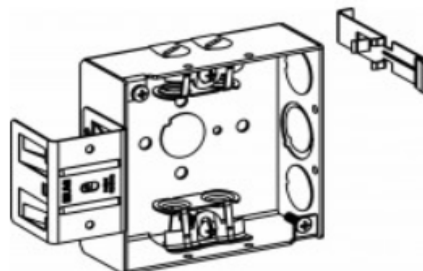

FLEX243

Catalog Number	Description	Sides	Knockouts	Bottom	Cubic Inches	Ship Case	Weight/Case
FLEX238	2-1/8" deep 1/2" & 3/4" eccentric KOs with MS bracket	(6) - 1/2", (3) - 1/2" & 3/4" Ecc	(3) - 1/2" (2) - 1/2" & 3/4" Ecc		30.3	25	26
FLEX243	2-1/8" deep 1/2" & 3/4" eccentric KO with MC clamp and MS bracket	(2) - 1/2" & (1) - 1/2" & 3/4" Ecc & 4 pryouts	(1) - 1/2"		30.3	25	26

4-11/16" Square Welded Boxes 2-1/8" Deep



Features

- Welded
- 2-1/8" deep
- Available in multiple KO sizes, with eccentric or concentric KOs, raised ground emboss with installed 10/32 ground screw and pigtail where noted

Applications

- 4-11/16" square welded junction boxes are used in a variety of industrial applications where larger sized conductors or wiring devices are needed and more volume is required
- Can be installed in walls or ceilings for lighting fixtures, switches, receptacles or other outlet devices. 2-1/8" deep boxes offer extra cubic capacity

Standard Material

- Galvanized steel

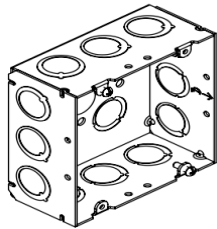

FLEX257

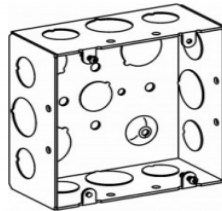

FLEX72171-1234

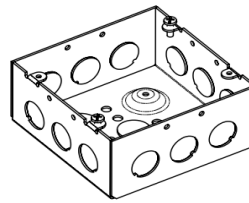

FLEX72171-1/2

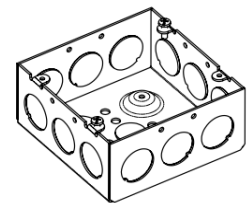

FLEX72171-3/4

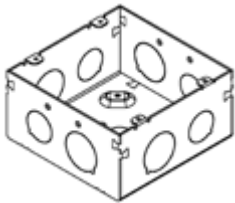

FLEX265

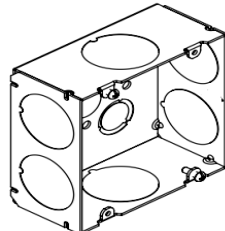

FLEX259

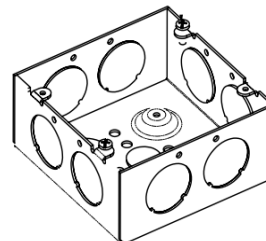

FLEX258

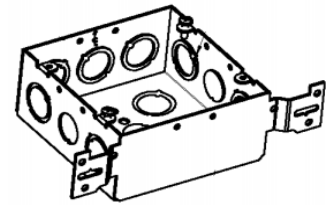

FLEX254

Catalog Number	Description	Knockouts		Cubic Inches	Ship Case	Weight/Case
		Sides	Bottom			
FLEX257	2-1/8" deep 1/2" & 3/4" concentric KO with raised ground emboss	(12) - 1/2" & 3/4" Con	(2) - 1/2" & 3/4" Con & (2) - 1 1/2"	42	25	28
FLEX72171-1234	2-1/8" deep 1/2" & 3/4" KO with raised ground emboss	(8) - 1/2" & (4) - 3/4"	(2) - 1/2" & (2) - 3/4"	42	25	28
FLEX72171-1/2	2-1/8" deep 1/2" KO with raised ground emboss	(12) - 1/2"	(2) - 1/2" & (2) - 3/4"	42	25	28
FLEX72171-3/4	2-1/8" deep 3/4" KO with raised ground emboss	(12) - 3/4"	(2) - 1/2" & (2) - 3/4"	42	25	28
FLEX265	2-1/8" deep 3/4" & 1" KO with raised ground emboss	(4) - 3/4" & (4) - 1"	(2) - 1/2" & (2) - 3/4"	42	25	28
FLEX259	2-1/8" deep 1-1/4" KO with raised ground emboss	(6) - 1-1/4"	(2) - 1/2" & (2) - 3/4"	42	25	28
FLEX258	2-1/8" deep 1" KO with raised ground emboss	(8) - 1"	(2) - 1/2" & (2) - 3/4"	42	25	28
FLEX254	2-1/8" deep 1/2" & 3/4" concentric KO with FL bracket	(2) - 1/2" & (7) - 1/2" & 3/4" Con	(2) - 1/2" & (2) - 3/4"	42	25	27

3" x 2" Gangable Switch Boxes 1-1/2" Deep



Features

- Boxes – 1-1/2" deep
- Boxes – 7.5 cubic inches
- Available with adjustable plaster ears, NM clamps and MC clamps where noted

Applications

- 3"x 2" Switch boxes can be installed in walls or ceilings for lighting fixtures, switches, receptacles or other outlet devices
- Switch boxes are used to bring power to a number of electrical devices where multiple conductor runs are split in two or more directions
- The adjustable plaster ears allow for an easy "cut in" when switches or outlets need to be added

Standard Material

- Galvanized steel

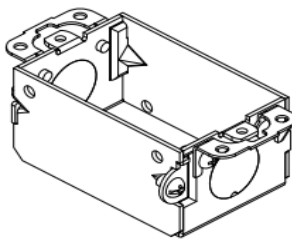

FLEX400

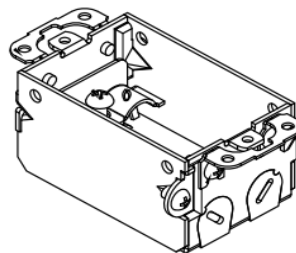

FLEX410

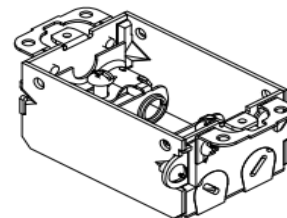

FLEX411

Catalog Number	Description	Sides	Knockouts Ends	Bottom	Cubic Inches	Ship Case	Weight/ Case
FLEX400	1-1/2" deep 1/2" KO	---	(2) - 1/2"	(1) - 1/2"	7.5	50	19
FLEX410	1-1/2" deep with NM Clamp	---	4 pryouts	---	7.5	50	21
FLEX411	1-1/2" deep with MC Clamp	---	4 pryouts	---	7.5	50	22

3" x 2" Gangable Switch Boxes

2" Deep



Features

- Boxes – 2" deep
- Boxes – 10.0 cubic inches
- Available with adjustable plaster ears, NM clamps and MC clamps where noted

Applications

- 3"x 2" Switch boxes can be installed in walls or ceilings for lighting fixtures, switches, receptacles or other outlet devices
- Switch boxes are used to bring power to a number of electrical devices where multiple conductor runs are split in two or more directions
- The adjustable plaster ears allow for an easy "cut in" when switches or outlets need to be added
- Boxes are gangable

Standard Material

- Galvanized steel

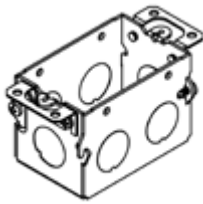

FLEX420

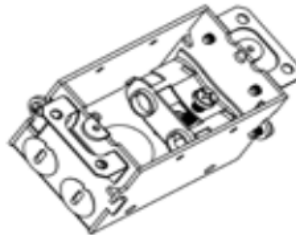

FLEX440

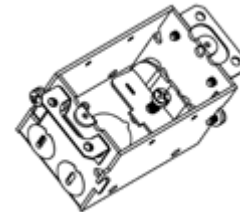

FLEX445

Catalog Number	Description	Knockouts			Cubic Inches	Ship Case	Weight/Case
		Sides	Ends	Bottom			
FLEX420	2" deep 1/2" KO	(4) - 1/2"	(2) - 1/2"	(2) - 1/2"	10.0	50	25
FLEX440	2" deep with MC Clamp	---	4 pryouts	(1) - 1/2"	10.0	50	27
FLEX445	2" deep with NM Clamp	---	4 pryouts	(1) - 1/2"	10.0	50	26

3" x 2" Gangable Switch Boxes

2-1/2" Deep

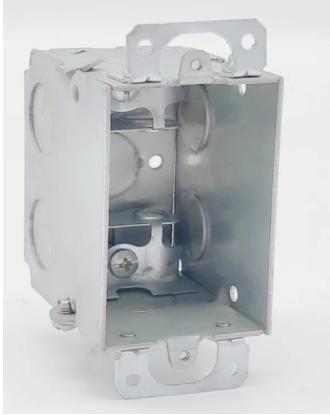

Features

- Boxes – 2-1/2" deep
- Boxes – 12.5 cubic inches
- Available with adjustable plaster ears, NM clamps and MC clamps where noted

Applications

- 3"x 2" Switch boxes can be installed in walls or ceilings for lighting fixtures, switches, receptacles or other outlet devices
- Switch boxes are used to bring power to a number of electrical devices where multiple conductor runs are split in two or more directions
- The adjustable plaster ears allow for an easy "cut in" when switches or outlets need to be added

Standard Material

- Galvanized steel

Catalog Number	Description	Sides	Knockouts Ends	Bottom	Cubic Inches	Ship Case	Weight/ Case
FLEX500	2-1/2" deep 1/2" KO	(4) - 1/2"	(2) - 1/2"	(2) - 1/2"	12.5	50	24
FLEX502	2-1/2" deep 1/2" KO with Long B Bracket	(4) - 1/2"	(2) - 1/2"	(2) - 1/2"	12.5	50	27
FLEX503	2-1/2" deep 1/2" & 3/4" KO	(4) - 1/2"	(2) - 3/4"	(2) - 1/2"	12.5	50	24
FLEX504	2-1/2" deep 1/2" KO with TS Bracket	(4) - 1/2"	(2) - 1/2"	(2) - 1/2"	12.5	50	30
FLEX505	2-1/2" deep 1/2" & 3/4" KO with TS Bracket	(4) - 1/2"	(2) - 3/4"	(2) - 1/2"	12.5	50	30
FLEX509	2-1/2" deep 1/2" KO Old Work	(4) - 1/2"	(2) - 1/2"	(2) - 1/2"	12.5	50	28
FLEX512	2-1/2" deep 1/2" KO with NM Clamp, Old Work	(4) - 1/2"	(2) - 1/2" & 4 pryouts	(1) - 1/2"	12.5	50	31
FLEX518	2-1/2" deep 1/2" KO with MC Clamp	(4) - 1/2"	(2) - 1/2" & 4 pryouts	(1) - 1/2"	12.5	50	25
FLEX519	2-1/2" deep 1/2" KO with NM Clamp	(4) - 1/2"	(2) - 1/2" & 4 pryouts	(1) - 1/2"	12.5	50	27
FLEX522	2-1/2" deep 1/2" KO with MC Clamp & Long B Bracket	---	(2) - 1/2" & 4 pryouts	(1) - 1/2"	12.5	50	35
FLEX523	2-1/2" deep 1/2" KO with MC Clamp, Old Work	---	(2) - 1/2" & 4 pryouts	(1) - 1/2"	12.5	50	32
FLEX524	2-1/2" deep 1/2" KO with MC Clamp & TS Bracket	---	(2) - 1/2" & 4 pryouts	(1) - 1/2"	12.5	50	35
FLEX529	2-1/2" deep 1/2" KO with NM Clamp & Long B Bracket	---	(2) - 1/2" & 4 pryouts	(1) - 1/2"	12.5	50	34
FLEX531	2-1/2" deep 1/2" KO with NM Clamp & TS Bracket	---	(2) - 1/2" & 4 pryouts	(1) - 1/2"	12.5	50	34

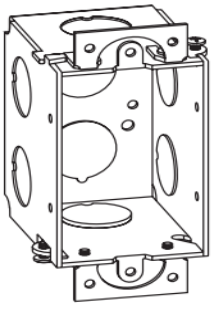

FLEX500

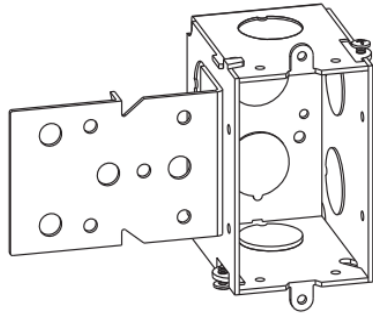

FLEX502

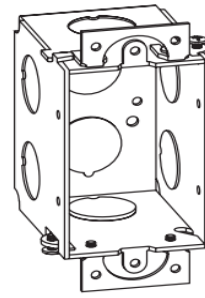

FLEX503

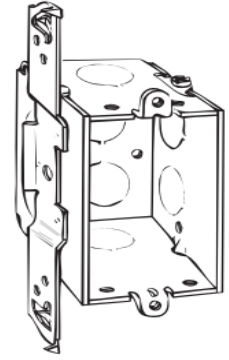

FLEX504

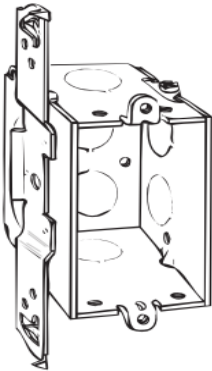

FLEX505

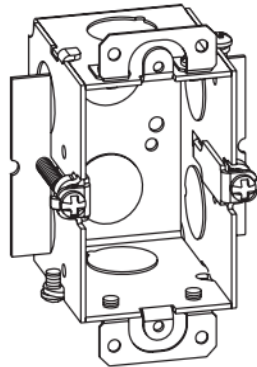

FLEX509

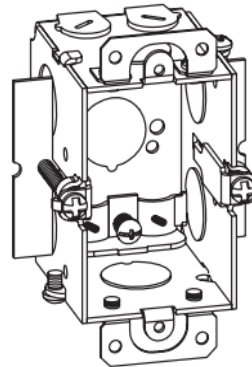

FLEX512

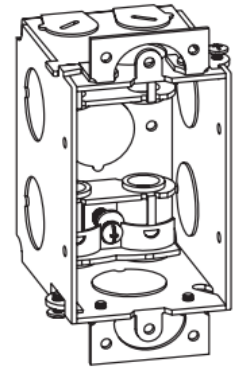

FLEX518

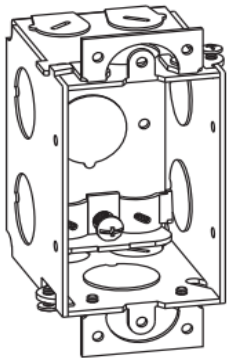

FLEX519

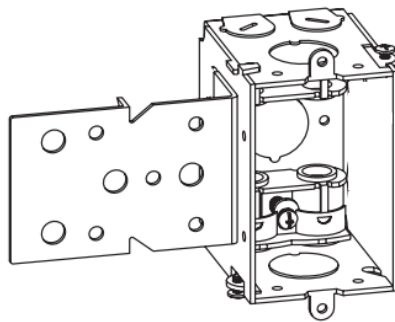

FLEX522

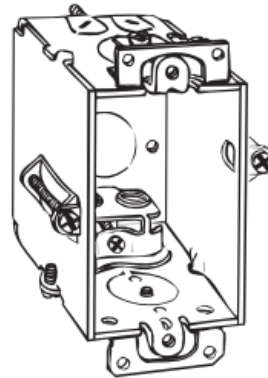

FLEX523

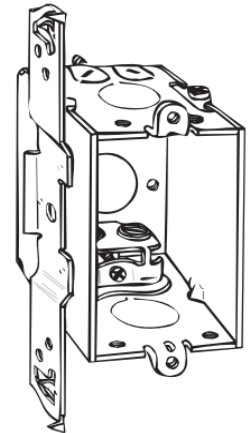

FLEX524

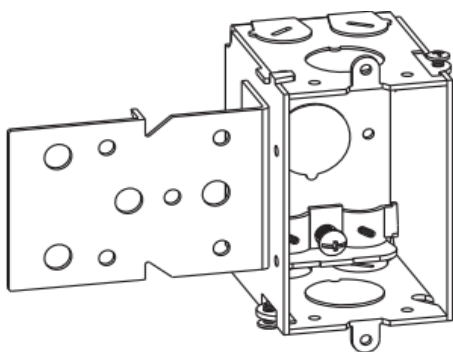

FLEX529

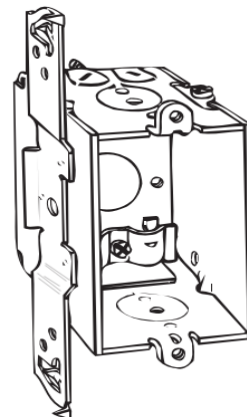

FLEX531

3" x 2" Gangable Switch Boxes

2-3/4" Deep



Features

- Boxes – 2-3/4" deep
- Boxes – 14.0 cubic inches
- Available with adjustable plaster ears, NM clamps and MC clamps where noted
- Gangable

Applications

- 3"x 2" Switch boxes can be installed in walls or ceilings for lighting fixtures, switches, receptacles or other outlet devices
- Switch boxes are used to bring power to a number of electrical devices where multiple conductor runs are split in two or more directions
- The adjustable plaster ears allow for an easy "cut in" when switches or outlets need to be added

Standard Material

- Galvanized steel

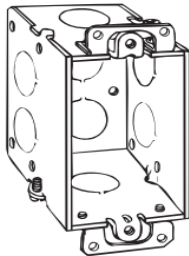

FLEX560

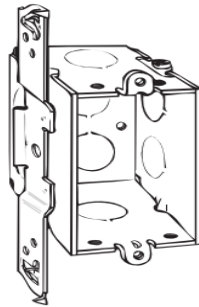

FLEX562

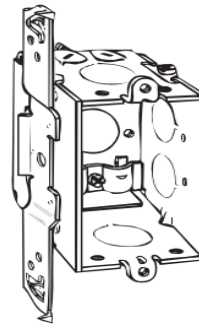

FLEX564

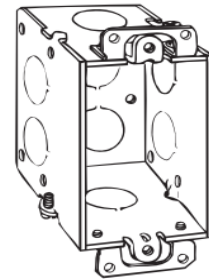

FLEX565

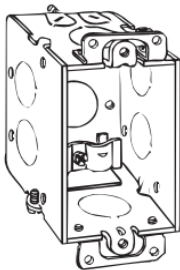

FLEX567

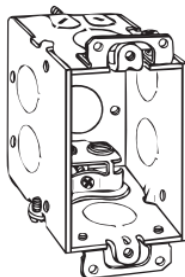

FLEX570

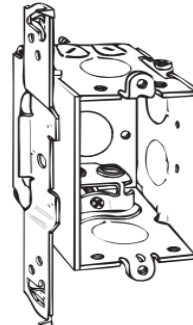

FLEX574

Catalog Number	Description	Sides	Knockouts Ends	Bottom	Cubic Inches	Ship Case	Weight/Case
FLEX560	2-3/4" deep 1/2" KO	(4) - 1/2"	(2) - 1/2"	(2) - 1/2"	14.0	50	27
FLEX562	2-3/4" deep 1/2" KO with TS Bracket	(4) - 1/2"	(2) - 1/2"	(2) - 1/2"	14.0	50	30
FLEX564	2-3/4" deep 1/2" KO with NM Clamp & TS Bracket	(4) - 1/2"	(2) - 1/2" & 4 pryouts	(1) - 1/2"	14.0	50	34
FLEX565	2-3/4" deep 1/2" & 3/4" KO	(4) - 3/4"	(2) - 3/4"	(2) - 1/2"	14.0	50	28
FLEX567	2-3/4" deep 1/2" KO with NM Clamp	(4) - 1/2"	(2) - 1/2"	(1) - 1/2"	14.0	50	29
FLEX570	2-3/4" deep 1/2" KO with MC Clamp	(4) - 1/2"	(2) - 1/2" & 4 pryouts	(1) - 1/2"	14.0	50	28
FLEX574	2-3/4" deep 1/2" KO with MC Clamp & TS Bracket	(4) - 1/2"	(2) - 1/2" & 4 pryouts	(1) - 1/2"	14.0	50	38

3" x 2" Gangable Switch Boxes

3-1/2" Deep



Features

- Boxes – 3-1/2" deep
- Boxes – 18.0 cubic inches
- Available with adjustable plaster ears, NM clamps and MC clamps where noted
- Gangable

Applications

- 3" x 2" Switch boxes can be installed in walls or ceilings for lighting fixtures, switches, receptacles or other outlet devices
- Switch boxes are used to bring power to a number of electrical devices where multiple conductor runs are split in two or more directions
- The adjustable plaster ears allow for an easy "cut in" when switches or outlets need to be added

Standard Material

- Galvanized steel

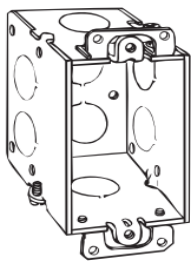

FLEX590

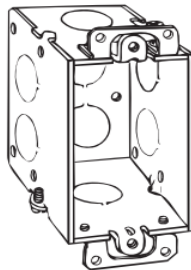

FLEX591

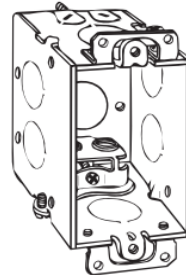

FLEX600

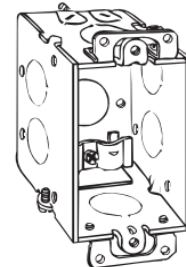

FLEX601

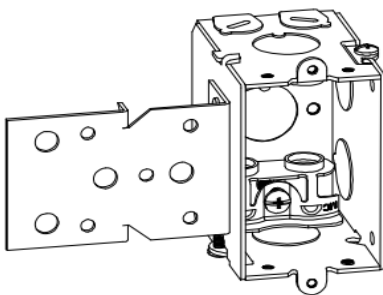

FLEX603

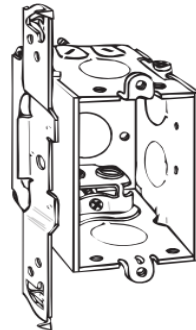

FLEX604

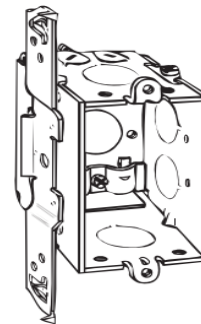

FLEX605

Catalog Number	Description	Sides	Knockouts Ends	Bottom	Cubic Inches	Ship Case	Weight/Case
FLEX590	3-1/2" deep 1/2" KO	(4) - 1/2"	(4) - 1/2"	(1) - 1/2"	18	25	17
FLEX591	3-1/2" deep 3/4" KO	(4) - 3/4"	(4) - 3/4"	(2) - 3/4"	18	25	17
FLEX600	3-1/2" deep 1/2" KO with MC Clamp	(4) - 1/2"	(2) - 1/2" & 4 pryouts	(1) - 1/2"	18	25	18
FLEX601	3-1/2" deep 1/2" KO with NM Clamp	(4) - 1/2"	(2) - 1/2" & 4 pryouts	(1) - 1/2"	18	25	17
FLEX603	3-1/2" deep 1/2" KO with MC Clamp & Long B Bracket	(4) - 1/2"	(2) - 1/2" & 4 pryouts	(1) - 1/2"	18	25	30
FLEX604	3-1/2" deep 1/2" KO with MC Clamp & TS Bracket	(4) - 1/2"	(2) - 1/2" & 4 pryouts	(1) - 1/2"	18	25	27
FLEX605	3-1/2" deep 1/2" KO with NM Clamp & TS Bracket	(4) - 1/2"	(2) - 1/2" & 4 pryouts	(1) - 1/2"	18	25	23

4" x 2" Drawn Handy Boxes and Extension 1-7/8" Deep



Features

- Boxes – Drawn
- Boxes – 1-7/8" deep
- Boxes – 13.0 cubic inches
- Available in multiple KO sizes, with or without concentric KOs and raised ground emboss with installed 10/32 ground screw where noted

Applications

- Handy boxes, also referred to as utility boxes are used for switch boxes, convenience outlets or small junction boxes in exposed work applications
- Great for appliances and machinery
- Flexotek handy utility boxes have a small, rectangular design that enables power outlets and switches to be installed in small places
- Can easily be customized with special holes or knockouts for OEM applications

Standard Material

- Galvanized steel

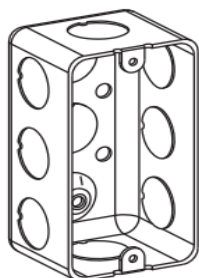

FLEX660

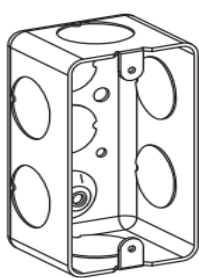

FLEX663

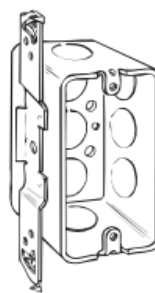

FLEX662

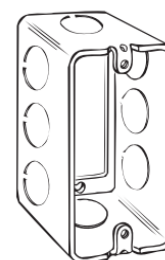

FLEX665

Catalog Number	Description	Sides	Knockouts Bottom	Cubic Inches	Ship Case	Weight/Case
BOXES						
FLEX660	1-7/8" deep 1/2" KO with raised ground emboss	(8) - 1/2"	(2) - 1/2"	13.0	50	24
FLEX663	1-7/8" deep 3/4" KO with raised ground emboss	(6) - 3/4"	(1) - 3/4"	13.0	50	24
FLEX662	1-7/8" deep 1/2" KO with raised ground emboss and TS bracket	(5) - 1/2"	(2) - 1/2"	13.0	50	24
EXTENSION						
FLEX665	1-7/8" deep extension	(8) - 1/2"	---	13.0	50	30

4" Octagon Concrete Rings & Covers



Features

- Available with 1/2" and 3/4" KO
- Available in multiple depths
- Mounting tabs allow for quick and easy installation
- Sealed KOs prevent wet concrete and water from entering the box

Applications

- Octagon concrete boxes with 1/2" & 3/4" side knockouts are used in poured concrete construction.
- Install on wooden or steel concrete forms once the forms are removed the boxes and conduit are buried in concrete and the end is open to the room wall or ceiling, ready for wire pulling
- Includes extra-long external mounting tabs allow an easy installation by nailing or screwing the boxes to wooden or steel concrete forms
- Knockouts are sealed against box surface to prevent wet concrete and water from entering the box. The top covers are removable allowing any before-pour work



FLEX270

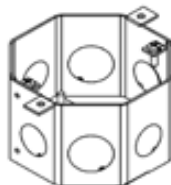

FLEX271

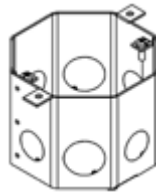

FLEX272

Standard Material

- Galvanized Steel

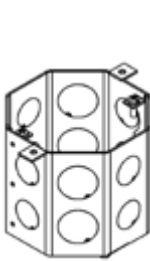

FLEX273

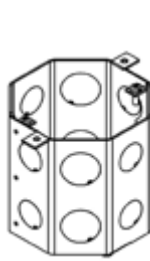

FLEX274

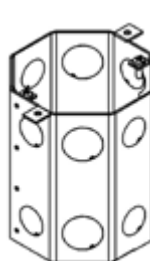

FLEX275

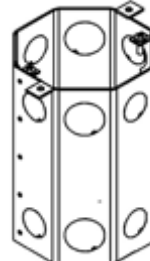

FLEX276

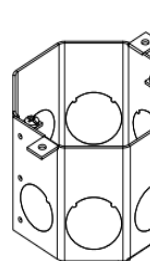

FLEX277

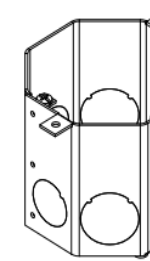

FLEX278

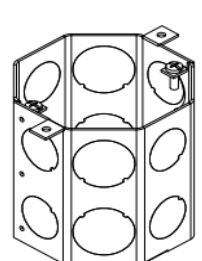

FLEX279

Catalog Number	Description	Sides	Ship Case	Weight/Case	Cubic Inches
RINGS					
FLEX270	Raised 2"	(4) - 1-1/2" & (4) - 3/4"	25	5	24.5
FLEX271	Raised 2-1/2"	(4) - 1-1/2" & (4) - 3/4"	25	6	30.8
FLEX272	Raised 3"	(4) - 1-1/2" & (4) - 3/4"	25	20	37
FLEX273	Raised 3-1/2"	(8) - 1-1/2" & (8) - 3/4"	20	19	43
FLEX274	Raised 4"	(8) - 1-1/2" & (8) - 3/4"	20	21	49.3
FLEX275	Raised 5"	(8) - 1-1/2" & (8) - 3/4"	10	13	61.5
FLEX276	Raised 6"	(8) - 1-1/2" & (8) - 3/4"	10	16	74
FLEX277	Raised 3"	(4) - 1" & (4) - 3/4"	25	23	37
FLEX278	Raised 3-1/2"	(4) - 1" & (4) - 3/4"	20	18	43
FLEX279	Raised 4"	(8) - 1" & (8) - 3/4"	20	21	49.3
COVERS					
FLEX890	Blank (1) Slot, (1) Hole	---	50	10	Flat
FLEX891	(2) -1/2" & (2) 3/4"	---	50	12	Flat
FLEX892	(3) -1/2" & (2) 3/4"	---	50	10	Flat



FLEX890

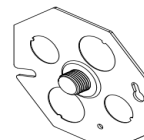

FLEX891



FLEX892

Masonry Boxes 2-1/2" Deep



Features

- Welded
- 2- 1/2" deep
- Concentric KOs
- 6/32 Tab holes for mounting devices
- Available in 1 thru 6 gang

Applications

- Solid, 2-1/2" deep, multi-gang masonry boxes are used for mounting switches, plugs, outlets and other electronic and electrical devices in masonry, brick and 4" block walls.
- Extra deep design allows for deep devices, numerous wires, switches and other electronic and electrical devices.

Standard Material

- Galvanized steel



FLEX690



FLEX691

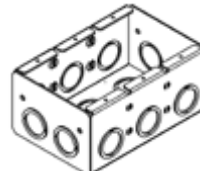

FLEX692

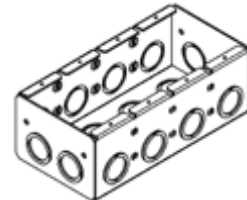

FLEX693

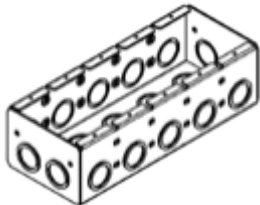

FLEX694

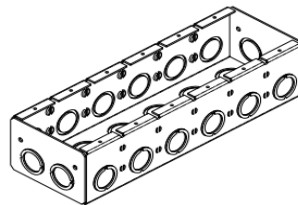

FLEX960

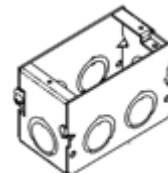

FLEX688

Catalog Number	Description	Sides	Knockouts		Cubic Inches	Ship Case	Weight/ Case
				Bottom			
FLEX690	1 gang	(6) - 1/2" & 3/4"	Con	(2) - 1/2" & 3/4"	16	20	12
FLEX691	2 gang	(8) - 1/2" & 3/4"	Con	(4) - 1/2" & 3/4"	31.8	20	9
FLEX692	3 gang	(10) - 1/2" & 3/4"	Con	(6) - 1/2" & 3/4"	47.8	10	11
FLEX693	4 gang	(12) - 1/2" & 3/4"	Con	(8) - 1/2" & 3/4"	63.5	10	16
FLEX694	5 gang	(14) - 1/2" & 3/4"	Con	(10) - 1/2" & 3/4"	79.5	10	20
FLEX960	6 gang	(16) - 1/2" & 3/4"	Con	(12) - 1/2" & 3/4"	95.3	1	2
FLEX688	1 gang gangable	(6) - 1/2" & 3/4"	Con	(2) - 1/2" & 3/4"	16	20	12

Masonry Boxes 3-1/2" Deep



Features

- Welded
- 3- 1/2" deep
- concentric KOs
- 6/32 Tab holes for mounting devices
- Available in 1 thru 6 gang

Applications

- Solid, multi-gang masonry boxes are used for mounting switches, plugs, outlets and other electronic and electrical devices in masonry, brick and 4" block walls.
- Extra deep design allows for deep devices, numerous wires, switches and other electronic and electrical devices.

Standard Material

- Galvanized steel



FLEX695



FLEX696

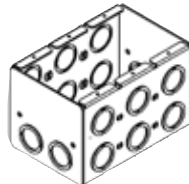

FLEX697

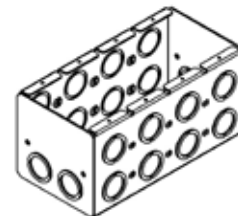

FLEX698

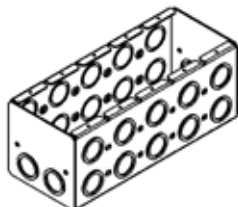

FLEX699

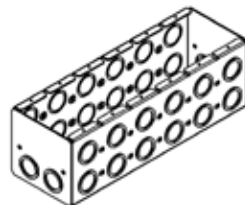

FLEX965

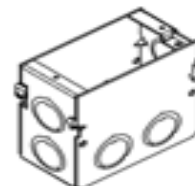

FLEX689

Catalog Number	Description	Sides	Knockouts	Bottom	Cubic Inches	Ship Case	Weight/ Case
FLEX695	1 gang	(8) 1/2" & 3/4"	Con	(2) 1/2" & 3/4"	21	20	14
FLEX696	2 gang	(12) 1/2" & 3/4"	Con	(4) 1/2" & 3/4"	44	10	10
FLEX697	3 gang	(16) 1/2" & 3/4"	Con	(6) 1/2" & 3/4"	65	10	15
FLEX698	4 gang	(20) 1/2" & 3/4"	Con	(8) 1/2" & 3/4"	87	5	9
FLEX699	5 gang	(24) 1/2" & 3/4"	Con	(10) 1/2" & 3/4"	108	1	2
FLEX965	6 gang	(28) 1/2" & 3/4"	Con	(12) 1/2" & 3/4"	160	1	3
FLEX689	1 gang gangable	(8) 1/2" & 3/4"	Con	(2) 1/2" & 3/4"	21	20	14

Masonry Boxes with Flat Bracket

2-1/2" Deep



Features

- 2- 1/2" deep
- Welded
- Available with 1/2" & 3/4" concentric KO's with FL bracket
- Available in 3 thru 4 gang

Applications

- Use when more than two devices or outlets are required in one box
- Multi-gang switch boxes can be installed in walls or ceilings for lighting fixtures, switches, receptacles or other outlet devices
- Use to bring power to a number of electrical devices where multiple conductor runs are split in two or more directions

Standard Material

- Galvanized steel

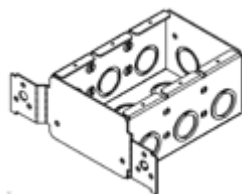

FLEX686

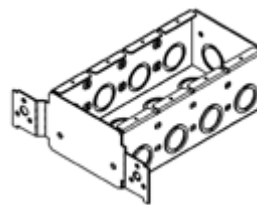

FLEX687

Catalog Number	Description	Sides	Knockouts Bottom	Cubic Inches	Ship Case	Weight/ Case
FLEX686	3 gang	(8) 1-1/2" & 3/4" Con	(6) 1/2" & 3/4" Con	47.8	10	14
FLEX687	4 gang	(10) 1-1/2" & 3/4" Con	(8) 1/2" & 3/4" Con	63.5	10	17

Multi-Gang Switch Boxes

2-1/2" Deep



LISTED
E530651

Features

- 2- 1/2" deep
- Welded
- Available with 1/2" and 3/4" concentric KOs
- Available in 2 thru 9 gang

Applications

- Use when more than two devices or outlets are required in one box
- Multi-Gang Switch boxes can be installed in walls or ceilings for lighting fixtures, switches, receptacles or other outlet devices
- Use to bring power to a number of electrical devices where multiple conductor runs are split in two or more directions

Standard Material

- Galvanized steel

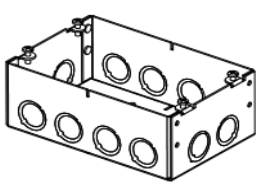

FLEX941

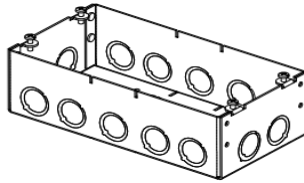

FLEX942

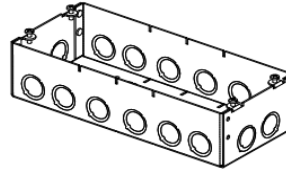

FLEX943

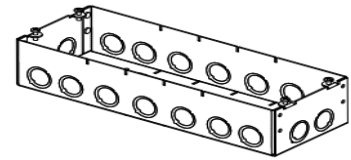

FLEX944

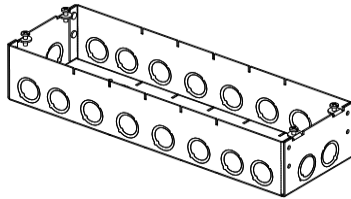

FLEX945

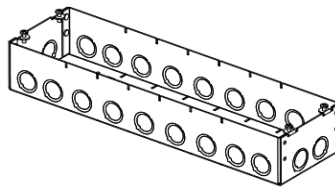

FLEX946

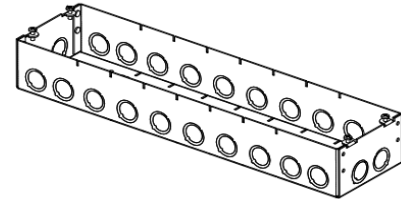

FLEX947

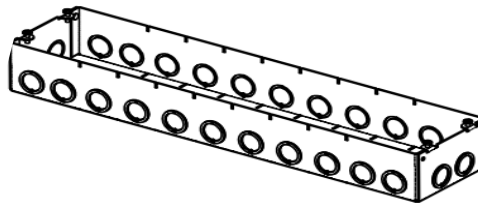

FLEX948

Catalog Number	Description	Sides	Knockouts	Bottom	Cubic Inches	Ship Case	Weight/ Case
FLEX941	2 gang	(12) -1/2" & 3/4" Con	(4) - 1/2" & (2) - 3/4"		70	5	6.6
FLEX942	3 gang	(14) -1/2" & 3/4" Con	(6) - 1/2" & (4) - 3/4"		90	5	10
FLEX943	4 gang	(16) -1/2" & 3/4" Con	(6) - 1/2" & (4) - 3/4"		110	5	11
FLEX944	5 gang	(18) -1/2" & 3/4" Con	(6) - 1/2" & (4) - 3/4"		130	5	13
FLEX945	6 gang	(20) -1/2" & 3/4" Con	(6) - 1/2" & (4) - 3/4"		150	1	2.4
FLEX946	7 gang	(22) -1/2" & 3/4" Con	(6) - 1/2" & (4) - 3/4"		169.5	1	2.8
FLEX947	8 gang	(24) -1/2" & 3/4" Con	(6) - 1/2" & (4) - 3/4"		188.8	1	3.3
FLEX948	9 gang	(26) -1/2" & 3/4" Con	(6) - 1/2" & (4) - 3/4"		208	1	4

Multi-Gang Switch Boxes

1-5/8" Deep



Features

- 1- 5/8" deep
- Welded
- Available with 1/2" and 3/4" concentric KOs
- Available in 2 thru 9 gang

Applications

- Use when more than two devices or outlets are required in one box
- Multi-Gang Switch boxes can be installed in walls or ceilings for lighting fixtures, switches, receptacles or other outlet devices
- Use to bring power to a number of electrical devices where multiple conductor runs are split in two or more directions

Standard Material

- Galvanized steel

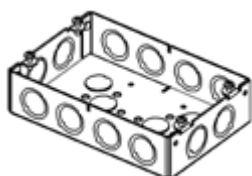

FLEX951

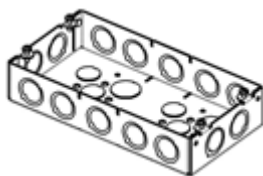

FLEX952

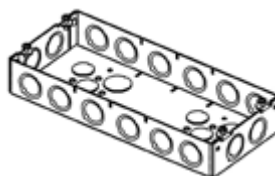

FLEX953

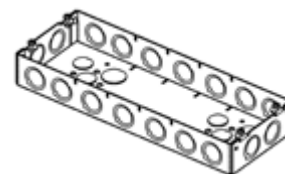

FLEX954

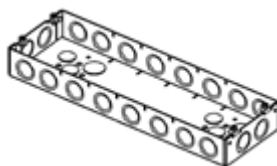

FLEX955

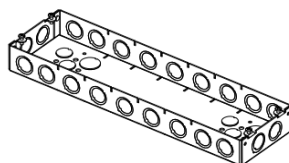

FLEX956

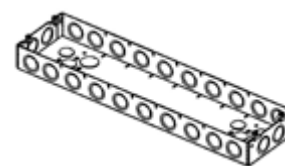

FLEX957

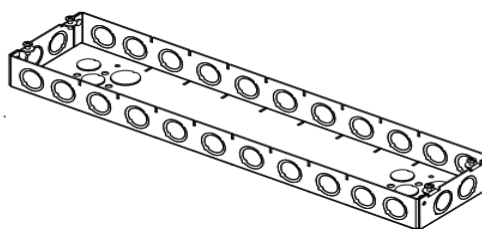

FLEX958

Catalog Number	Description	Knockouts		Cubic Inches	Ship Case	Weight/Case
		Sides	Bottom			
FLEX951	2 gang	(12) - 1/2" & 3/4"	(4)- 1/2" & (2) - 3/4"	47	5	7
FLEX952	3 gang	(14) - 1/2" & 3/4"	(6) - 1/2" & (4) - 3/4"	60	5	7.5
FLEX953	4 gang	(16) - 1/2" & 3/4"	(6) - 1/2" & (4) - 3/4"	72.8	5	9
FLEX954	5 gang	(18) - 1/2" & 3/4"	(6) - 1/2" & (4) - 3/4"	85.8	5	10
FLEX955	6 gang	(20) - 1/2" & 3/4"	(6) - 1/2" & (4) - 3/4"	98.5	1	2
FLEX956	7 gang	(22) - 1/2" & 3/4"	(6) - 1/2" & (4) - 3/4"	111.5	1	2.5
FLEX957	8 gang	(24) - 1/2" & 3/4"	(6) - 1/2" & (4) - 3/4"	124.5	1	3
FLEX958	9 gang	(26) - 1/2" & 3/4"	(6) - 1/2" & (4) - 3/4"	137.3	1	3.5

4" Square Single Gang Device Rings & Covers



LISTED

E530651

Features

- Ideal for exposed work applications, providing an easy method for the installation of electrical devices
- Can be used on any 4" square box

Applications

- 4" single gang device rings are used with 4" square boxes to mount switches, receptacles and devices
- Angled slots on the covers compensate for up to 12° of box misalignment on upright framing members
- 4" square blank flat covers are used to cover 4" square box wiring and provide a means for access when future conduit runs are required

Standard Material

- Galvanized steel

Catalog Number	Description	Depth	Cubic Inches	Ship Case	Weight/Case
DEVICE RINGS					
FLEX787	Flat	---	---	50	9
FLEX771	Raised 1/4"	1/4"	1.5	50	10
FLEX782	Raised 1/2"	1/2"	3.5	50	12
FLEX768	Raised 5/8"	5/8"	4.5	50	13
FLEX773	Raised 3/4"	3/4"	5.5	50	15
FLEX774	Raised 1"	1"	7.5	25	9
FLEX775	Raised 1-1/4"	1-1/4"	9.4	25	10.5
FLEX785	Raised 1-1/2"	1-1/2"	11.3	25	11
FLEX786	Raised 2"	2"	14.5	25	13
COVERS					
FLEX752	Blank flat	Flat	---	50	15
FLEX753	1/2" KO flat	Flat	---	50	15

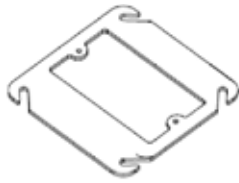

FLEX787

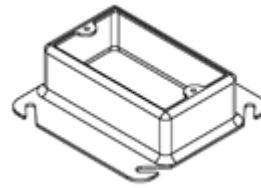

FLEX775

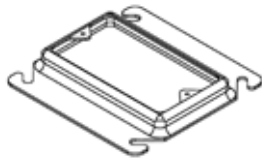

FLEX771

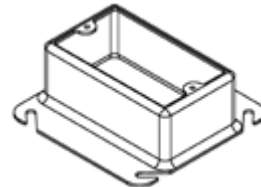

FLEX785

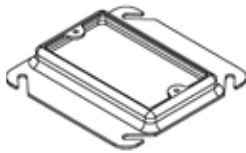

FLEX782

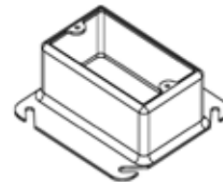

FLEX786

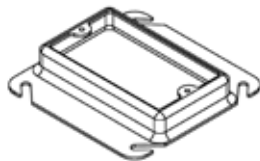

FLEX768

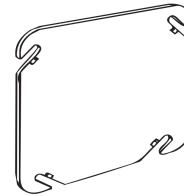

FLEX752

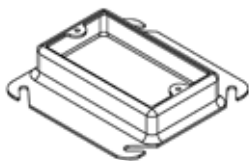

FLEX773

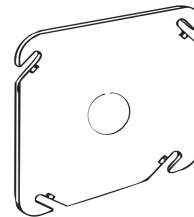

FLEX753

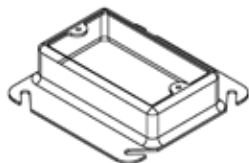

FLEX774

4" Square Double Gang Device Rings



Features

- Ideal for exposed work applications, providing an easy method for the installation of electrical devices
- Can be used on any 4" square box

Applications

- 4" double gang device rings are used with 4" square boxes to mount switches, receptacles and devices
- Angled slots on the covers compensate for up to 12° of box misalignment on upright framing members
- Four slots for mounting vertically or horizontally

Standard Material

- Galvanized steel

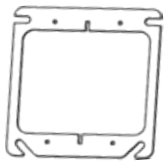

FLEX791

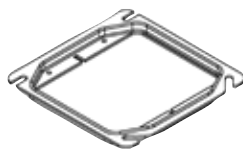

FLEX777

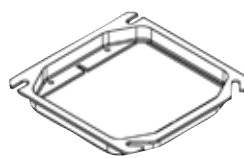

FLEX768

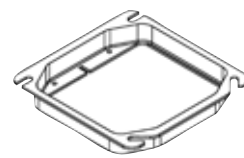

FLEX769

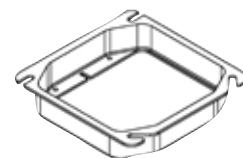

FLEX779

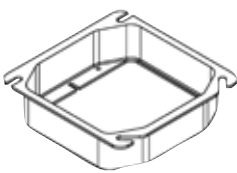

FLEX780

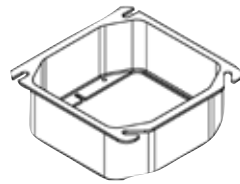

FLEX781

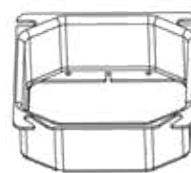

FLEX795



FLEX796

Catalog Number	Description	Depth	Cubic Inches	Ship Case	Weight/Case
FLEX791	Flat	Flat	---	50	15
FLEX777	Raised 1/4"	1/4"	2.3	50	9
FLEX768	Raised 1/2"	1/2"	5.4	50	9
FLEX769	Raised 5/8"	5/8"	7	50	10
FLEX779	Raised 3/4"	3/4"	8.5	50	11
FLEX780	Raised 1"	1"	11.6	25	7
FLEX781	Raised 1-1/4"	1-1/4"	14.7	25	9
FLEX795	Raised 1-1/2"	1-1/2"	15.5	25	10
FLEX796	Raised 2"	2"	20.7	25	13

4" Square to Round Device Rings



Features

- 4" square to round 1/2"- 2" raised device rings are used to mount light fixtures in walls and ceilings
- They convert a square box to a round ceiling or wall opening with 8-32 threaded mounting tabs 2.75" c.c.

Applications

- Use to mount ceiling lights or wall scone lights
- The angled slots on the covers compensate for up to 12° of box misalignment on upright framing members

Standard Material

- Galvanized steel

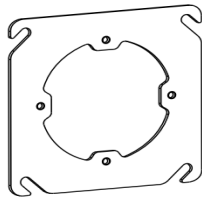

FLEX4SC-F

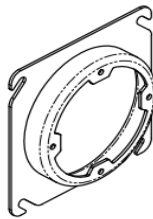

FLEX767

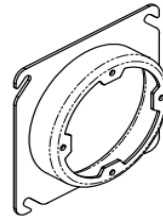

FLEX756

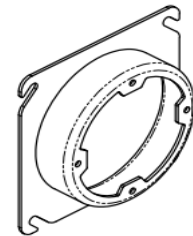

FLEX759

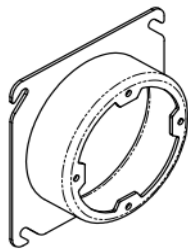

FLEX757

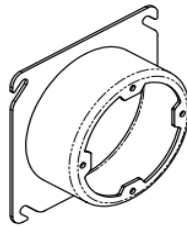

FLEX758

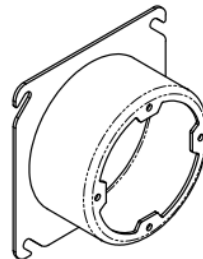

FLEX4SC150

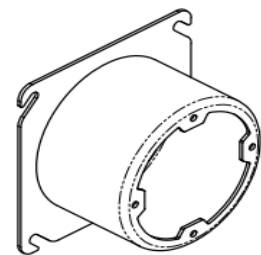

FLEX4SC200

Catalog Number	Description	Depth	Cubic Inches	Ship Case	Weight/ Case
FLEX4SC-F	FLAT	---	---	50	9
FLEX767	1/2" raised	1/2"	3	50	12
FLEX756	5/8" raised	5/8"	4	50	13
FLEX759	3/4" raised	3/4"	5	50	14
FLEX757	1" raised	1"	6.8	25	8
FLEX758	1-1/4" raised	1-1/4"	8.5	25	9
FLEX4SC150	1-1/2" raised	1-1/2"	9.7	25	10
FLEX4SC200	2" raised	2"	12.9	25	12

4" Industrial Covers



Features

- Includes hardware for mounting receptacles
- Available in various cover designs
- Crushed corners
- Raised 5/8"
- 6.6 cubic inch

Applications

- 4" square industrial surface covers allow for a quick installation of electrical devices to steel covers before they are mounted to the box
- Raised 5/8" to protect wires inside the box for switches, receptacles, and outlets

Standard Material

- Galvanized steel

Catalog Number	Description	Depth	Cubic Inches	Ship Case	Weight/Case
FLEX800	(1) Toggle switch	5/8"	6.6	50	30
FLEX801	(1) 15A 1.406" diameter	5/8"	6.6	50	27
FLEX803	(2) Toggle switches	5/8"	6.6	50	29
FLEX805	(1) Toggle Switch (1) 15A 1.406" diameter	5/8"	6.6	50	27
FLEX808	(1) GFI	5/8"	6.6	50	25
FLEX809	(2) GFI	5/8"	6.6	50	24
FLEX810	(1) 30A -50A 2.141" dia	5/8"	6.6	50	23
FLEX811	(1) 30A 1.719" diameter	5/8"	6.6	50	24
FLEX812	(1) 20A 1.60" diameter	5/8"	6.6	50	26
FLEX813	(1) 40A / 50A 2.155" diameter	5/8"	6.6	50	24
FLEX814	(1) Toggle (1) GFI	5/8"	6.6	50	24
FLEX902	(1) Duplex	5/8"	6.6	50	25
FLEX907	(2) Duplex receptacles	5/8"	6.6	50	22
FLEX915	(1) GFI (1) Duplex	5/8"	6.6	50	24

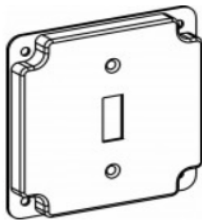

FLEX800

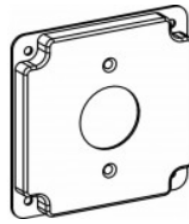

FLEX801

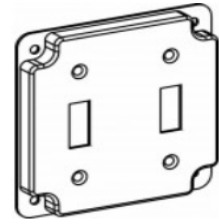

FLEX803

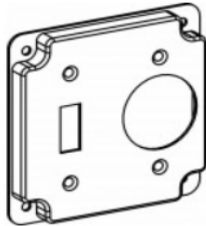

FLEX805

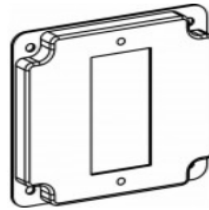

FLEX808

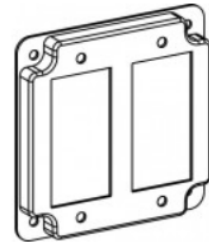

FLEX809

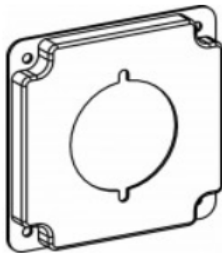

FLEX810

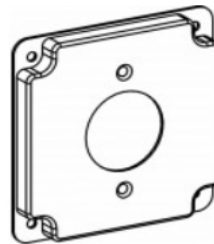

LEX811

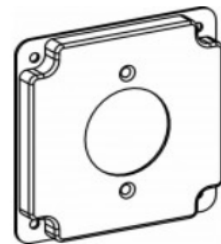

FLEX812

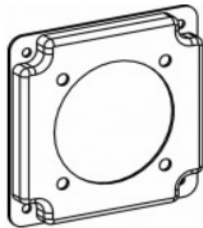

FLEX813

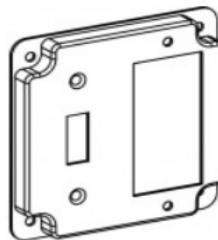

FLEX814

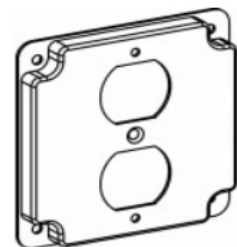

FLEX902

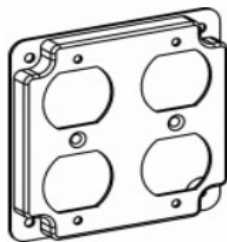

FLEX907

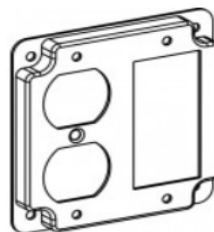

FLEX912

4-11/16" Square Single Gang Device Rings & Covers



LISTED
E530651

Features

- Ideal for exposed work applications, providing an easy method for the installation of electrical devices
- Can be used on any 4-11/16" square box

Applications

- 4-11/16" single gang device rings are used with 4-11/16" square boxes to mount switches, receptacles and devices
- Angled slots on the covers compensate for up to 12° of box misalignment on upright framing members
- 4-11/16" square blank flat covers are used to cover 4-11/16" square box wiring and provide a means for access when future conduit runs are required

Standard Material

- Galvanized steel

Catalog Number	Description	Depth	Cubic Inches	Ship Case	Weight/Case
DEVICE RINGS					
FLEX-416MG	Flat	---	---	50	14
FLEX-416MG25	Raised 1/4"	1/4"	1.5	50	10
FLEX837	Raised 1/2"	1/2"	3.5	50	12
FLEX843	Raised 5/8"	5/8"	4.5	50	19
FLEX838	Raised 3/4"	3/4"	5.5	50	20
FLEX839	Raised 1"	1"	7.5	25	11
FLEX842	Raised 1-1/4"	1-1/4"	9.4	25	12
FLEX898	Raised 1-1/2"	1-1/2"	11.3	25	13
FLEX899	Raised 2"	2"	14.5	25	15
COVERS					
FLEX832	Blank flat	Flat	---	50	21
FLEX833	1/2" KO flat	Flat	---	50	21

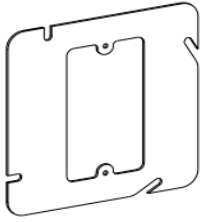

FLEX-416MG

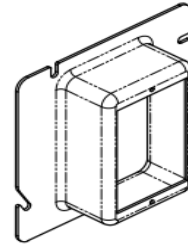

FLEX842

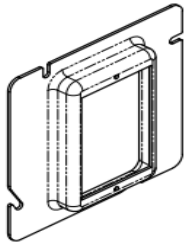

FLEX-416MG

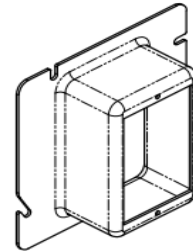

FLEX898

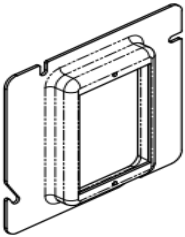

FLEX837

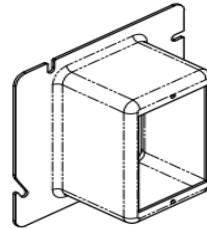

FLEX899

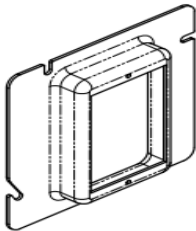

FLEX843

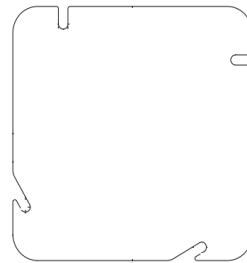

FLEX832

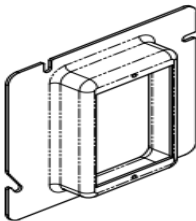

FLEX838

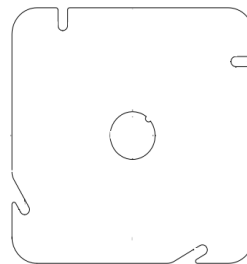

FLEX833

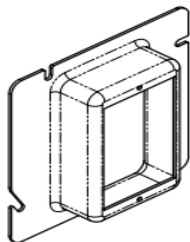

FLEX839

4-11/16" Square Double Gang Device Rings



Features

- Ideal for exposed work applications, providing an easy method for the installation of electrical devices
- Can be used on any 4-11/16" square box

Applications

- 4-11/16" double gang device rings are used with 4-11/16" square boxes to mount switches, receptacles and devices
- Angled slots on the covers compensate for up to 12° of box misalignment on upright framing members
- Four slots for mounting vertically or horizontally

Standard Material

- Galvanized steel

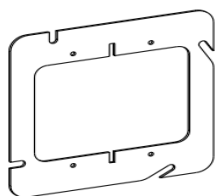

FLEX-416F

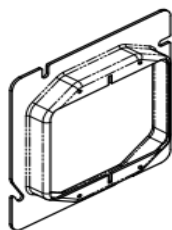

FLEX841

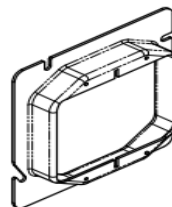

FLEX818

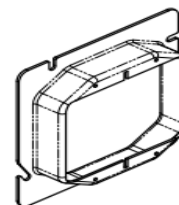

FLEX840

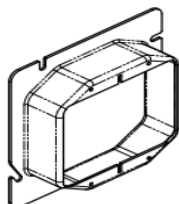

FLEX819

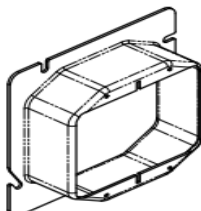

FLEX820

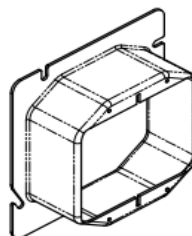

FLEX885

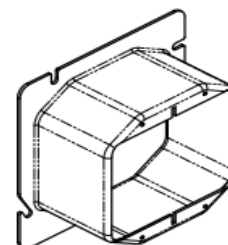

FLEXMG2R

Catalog Number	Description	Depth	Cubic Inches	Ship Case	Weight/Case
FLEX-416F	Flat	Flat	---	50	15
FLEX841	Raised 1/2"	1/2"	5.4	50	9
FLEX818	Raised 5/8"	5/8"	7	50	10
FLEX840	Raised 3/4"	3/4"	8.5	50	11
FLEX819	Raised 1"	1"	11.6	25	7
FLEX820	Raised 1-1/4"	1-1/4"	14.7	25	9
FLEX885	Raised 1-1/2"	1-1/2"	15.5	25	10
FLEXMG2R	Raised 2"	2"	20.7	25	13

4-11/16" Square to Round Device Rings



Features

- 4-11/16" square to round 1/2"- 2" raised device rings are used to mount light fixtures in walls and ceilings
- They convert a square box to a round ceiling or wall opening with 8-32 threaded mounting tabs 2.75" c.c.

Applications

- Use to mount ceiling lights or wall sconce lights
- The angled slots on the covers compensate for up to 12° of box misalignment on upright framing members

Standard Material

- Galvanized steel

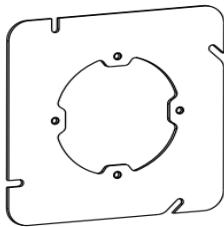

FLEX00SF

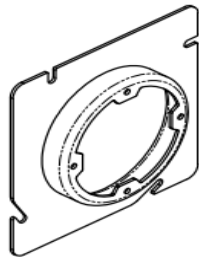

FLEX829

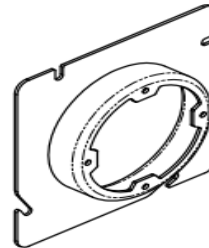

FLEX835

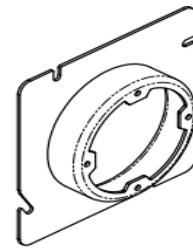

FLEX75SF

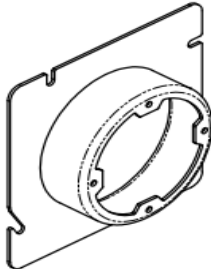

FLEX100SF

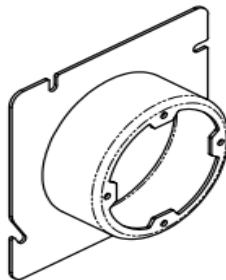

FLEX125SF

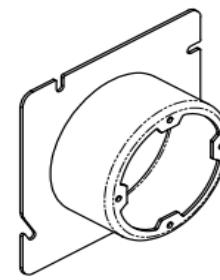

FLEX150SF

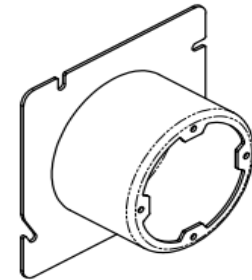

FLEX200SF

Catalog Number	Description	Depth	Cubic Inches	Ship Case	Weight/ Case
FLEX00SF	FLAT	---	---	50	12
FLEX829	1/2" raised	1/2"	3	50	17
FLEX835	5/8" raised	5/8"	4	50	18
FLEX75SF	3/4" raised	3/4"	5	50	18
FLEX100SF	1" raised	1"	6.8	25	11
FLEX125SF	1-1/4" raised	1-1/4"	8.5	25	12
FLEX150SF	1-1/2" raised	1-1/2"	9.7	25	13
FLEX200SF	2" raised	2"	12.9	25	15

Multi-Gang Box Covers Blank



Features

- Protects wires inside the box for switches receptacles and outlets
- Provides fast and easy coverage of electrical junction boxes
- Available in 2 thru 6 gang

Applications

- Blank covers are used to cover box wiring and provide means for access when future conduit runs are required

Standard Material

- Galvanized Steel



FLEX844



FLEX845



FLEX846

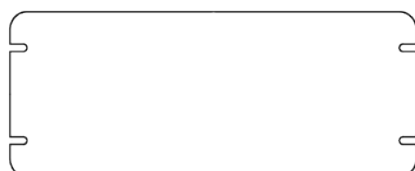

FLEX847



FLEX848

Catalog Number	Width	Description	Depth	Ship Case	Weight/Case
FLEX844	7-1/16"	2 gang	Flat	10	6
FLEX845	8-7/8"	3 gang	Flat	10	7
FLEX846	10 -11/16"	4 gang	Flat	10	9
FLEX847	12 -1/2"	5 gang	Flat	10	10
FLEX848	14-5/16"	6 gang	Flat	10	12

4" x 2" Handy Box Covers



Features

- Ideal for exposed work applications, providing an easy method for the installation of electrical devices
- Can be used on any 4"x2" rectangular box

Applications

- Handy box covers are used with handy boxes to protect wiring inside the box
- Manufactured from galvanized steel and offered in various designs for receptacles, switches and other devices

Standard Material

- Galvanized steel

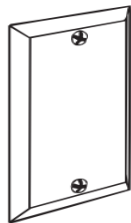

FLEX860

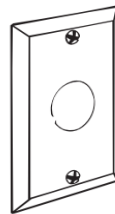

FLEX861

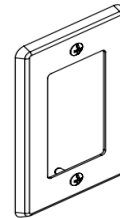

FLEX862

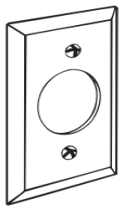

FLEX863



FLEX864

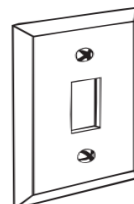

FLEX865

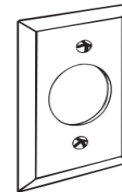

FLEX867

Catalog Number	Description	Depth	Cubic Inches	Ship Case	Weight/Case
FLEX860	Blank	Flat	1.5	25/250	26
FLEX861	1/2" KO	Flat	1.5	25/250	26
FLEX862	GFI	Flat	1.5	25/250	26
FLEX863	15A 1.406" diameter	Flat	1.5	25/250	26
FLEX864	Duplex	Flat	1.5	25/250	26
FLEX865	Toggle switch	Flat	1.5	25/250	26
FLEX867	30-50A 1.60" diameter	Flat	1.5	25/250	26

Multi-Gang Device Rings

3/4" Raised



Features

- Ideal for exposed work applications, providing an easy method for the installation of electrical devices
- Raised 3/4"
- Slots allow for easy installation
- Available in 2 thru 6 gang

Applications

- Multi-gang device rings are used with standard multi-gang boxes to mount switches, receptacles and devices

Standard Material

- Galvanized Steel

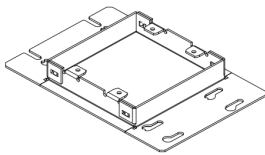

FLEX821

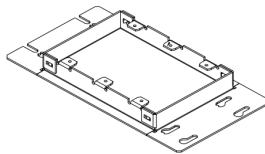

FLEX822

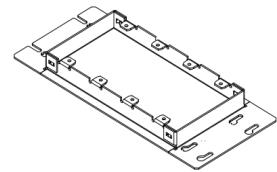

FLEX823

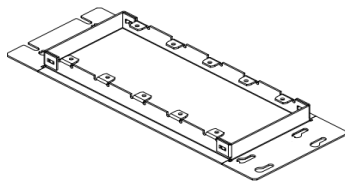

FLEX824

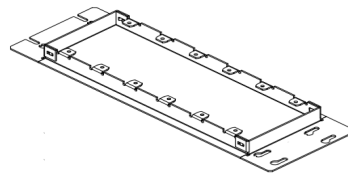

FLEX825

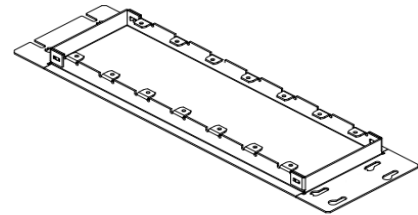

FLEX826

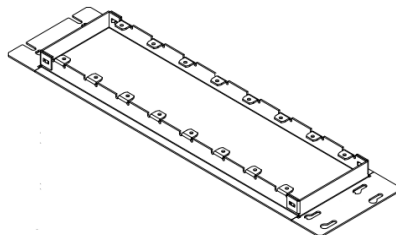

FLEX827

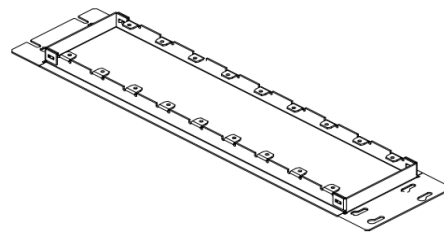

FLEX828

Catalog Number	Width	Description	Depth	Cubic Inches	Ship Case	Weight/Case
FLEX821	7 -1/16"	2 gang	3/4	11	20	11
FLEX822	8 -7/8"	3 gang	3/4"	17	20	12
FLEX823	10 -11/16"	4 gang	3/4"	21.5	20	14
FLEX824	12 -1/ 2"	5 gang	3/4"	26	10	8
FLEX825	14 -5/16"	6 gang	3/4"	30.5	10	9
FLEX826	16 -1/ 8"	7 gang	3/4"	35.5	5	7
FLEX827	17 -15/ 16"	8 gang	3/4"	40.8	5	9
FLEX828	19 -3/4"	9 gang	3/4"	45.8	5	10